



PETTTI GIUSEPPE s.p.a.

INDICE ARTICOLI

ART.	PAG.	ART.	PAG.	ART.	PAG.	ART.	PAG.
4100	1	1150/RR	42	1300/80	35	2RP/CF	26
1090AC/2	38	1150/RSF	32	1400/100	35	2RP/CU	8
1090AO/2	38	1150/S	33	1400/120	35	2RPM	9
1090CC/2	37	1150/W	34	1400/140	35	2RPP	12
1090CO/2	36	1150EC/F	32	1400/170	35	2RPPS	12
1090CO/2	37	1150R/F	32	1400/200	35	2RPS	9
1090MC/2	37	1150RR/AD	42	1400/80	35	309/25	1, 5, 10, 24, 26
1090MO/2	31	1150RR/AS	42	1500	31	309/30	1, 5, 10, 24, 26
1100	31	1150RSS	42	1500/100	36	309D	5, 10
1100/100	31	1150RSS/A	43	1500/120	36	309M/3-25	5, 10
1100/120	31	1150RSS/AD	42	1500/140	36	309M/3-30	5, 10
1100/140	31	1150RSS/AG	42	1500/160	36	309M-25	4
1100/160	31	1150RSS/AS	42	1500/60	36	309M-30	4
1100/180	31	1150RSSP	43	1500/80	36	310M/3-25	10
1100/200	31	1150RSSP/D	43	1600/10	44	310M/3-30	10
1100/40	31	1150RSSP/G	43	1600/11	44	310M-25	9
1100/60	31	1150RSSP/S	43	1600/12	44	310M-30	9
1100/80	32	116P	21	1600/13	44	311P	5, 10
1100/E	31	1180AC/2	38	1600/14	44	312	15, 29
1100/E-100	31	1180AC/3	39	1600/16	44	312/A	15, 29
1100/E-120	31	1180AC/4	40	1600/20	44	312A	15, 29
1100/E-140	31	1180AO/2	38	1640/110	36	312B	15, 28
1100/E-160	31	1180AO/3	39	1640/140	36	312BN/INOX	15, 28
1100/E-180	31	1180AO/4	40	1640/170	36	312R	20
1100/E-200	31	1180CC/2	37	1640/200	36	3150/RR	44
1100/E-40	31	1180CC/3	39	1700/100	36	316	20, 22, 23
1100/E-60	31	1180CC/4	40	1700/120	36	412	14, 28
1100/E-80	31	1180CO/2	37	1700/140	36	414	20
1100/E-C	32	1180CO/3	38	1700/160	36	416	21
1100/R	31	1180CO/4	39	1700/3C	5	465	11, 27
1100/RSF	32	1180FP/3	41	1700/60	36	475	6, 25
1100/S	33	1180MC/2	38	1700/80	36	4MLI	14
1100EC/F	32	1180MC/3	39	1750/3C	10	4MLP	14
1102 A	112	1180MC/4	40	1RMS	19	4RG	3
1102 B	112	1180MO/2	37	209S	5, 24	4RG/C	3
1107 A	112	1180MO/3	39	209S/18	5, 24	4RG/CF	24
112PN	15	1180MO/4	40	2100/RR	44	4RG/CU	3
112PZ	15	1200/100	36	210S	10, 26	4RGM	4
11300/100	35	1200/120	36	2200	112	4RGMT	4
11300/120	35	1200/140	36	2RG	3	4RGS	4
11300/140	35	1200/170	36	2RG/C	3	4RM	13
11300/80	36	1200/200	36	2RG/CF	24	4RMA	1
1140	35	1200/60	36	2RG/CU	3	4RMF	28
11400/100	35	1200/80	36	2RGM	4	4RMG	13
11400/140	35	1300/100	35	2RGS	4	4RP	8
1150/ASF	33	1300/120	35	2RM	13	4RP/C	8
1150/E	32	1300/140	35	2RMF	28	4RP/CF	26
1150/E-C	32	1300/170	35	2RMG	13	4RP/CU	8
1150/E-CA	33	1300/200	35	2RP	8	4RPM	9
1150/F	32	1300/60	35	2RP/C	8	4RPMT	9
1150/R	31					4RPP	12



ART.	PAG.
4RPPS	13
4RPS	9
5184100726	64
5935-0	111
5935-1	111
5935-2	111
5935-3	111
5935-4	111
5935-5	111
5935-6	111
5935-7	111
5935-8	111
5935-9	111
5936-0	111
5936-1	111
5936-2	111
5936-3	111
5936-4	111
5936-5	111
5936-6	111
5936-7	111
5936-8	111
5936-9	111
5937-0	111
5937-1	111
5937-2	111
5937-3	111
5937-4	111
5937-5	111
5937-6	111
5937-7	111
5937-8	111
5937-9	111
5941-A	111
5941-B	111
5941-C	111
5941-D	111
5941-E	111
5941-F	111
5941-G	111
5941-H	111
5941-I	111
5941-J	111
5941-K	111
5941-L	111
5941-M	111
5941-N	111
5941-O	111
5941-P	111
5941-Q	111
5941-R	111
5941-S	111
5941-T	111
5941-U	111
5941-V	111

ART.	PAG.
5941-W	111
5941-X	111
5941-Y	111
5941-Z	111
6000.2RS	52
6201.2RS	52
6202.2RS	52
6203.2RS	52
6204.2RS	52
6205.2RS	52
AF10	60
AF10PAR	60
AF10PAV	60
AF8	60
AF8PAR	60
AF8PAV	60
AFA38	60
AFA38PAV	61
AG/7	30
ALG10	11, 27
ALG12	29
ALG8	2
ALG9	6, 25
ARTU	46
ARTU/40	46
ASG10	11, 27
ASG12	29
ASG9	6, 25
B/C12	101
B/C14	101
B/C16	101
B/L12	101
B/L14	101
B/L16	101
B/Q12	101
B/Q14	101
B/Q16	101
B/QG12	99
B/QG14	99
B/QG16	99
B/T12	101
B/T14	101
B/T16	101
B/T20	101
B/TG12	99
B/TG14	99
B/TG16	99
B/TOT12	106
B/TOT14	106
B/TOT16	106
B/TT12	102
B/TT14	102
B/TT16	102
B/TT18	102
BA100	86

ART.	PAG.
BA110F	86
BA120F	86
BAS50	86
BAS60	86
BAS75Z	66
BAS90Z	68
BAS96Z	69
BG/2000	6, 11, 25, 27
BRE100	85
C2000/40	77
C2000/50	77
C2000LL/18	72
C2000LL/22	72
C2000LM/18	72
C2000LM/22	72
C2000LPM/18	72
C2000LPM/22	72
C2000LS/18	72
C2000LS/22	72
C2000LSR/18	72
C2000LSR/22	72
C2000PS	75
C2000PS/35	75
C2000PSR	75
C2000PSR/35	75
C2000R/30S	77
C2000R/30SP	77
C2000R/40S	77
C2000R/40SP	77
C2000R/50	75
C2000R/50P	75
C2000R/65	75
C2000R/65P	75
C2000RI/50	75
C2001/40	77
C2001/50	77
C25/10	50
C54C	82
C57	79
C75	80
C75/INOX	81
C87	81
CA/10	91
CA/10R	92
CA/12	91
CA/12R	92
CA/AP65	66
CA/AP80	67
CA/AP90	69
CAP40X55	62
CAP50X65	62
CAP50X82	62
CAP-B	43
CAP-M	43

ART.	PAG.
CAP-N	43
CAPCRA	43
CAPCRAS	43
CAPCRO	43
CAR/C	81
CAR/N	81
CAR/Z	81
CAV01	45
CC2000LL/16	71
CC2000LL/18	71
CC2000LL/22	71
CC2000LM/18	71
CC2000LM/22	71
CC2000LS/18	71
CC2000LS/20	71
CC2000LS/20INOX	71
CC2000LS/22	71
CC2000LS/24	71
CC2000LS/24INOX	71
CC2000LSR/18	71
CC2000LSR/20	71
CC2000LSR/22	71
CC2000LSR/24	71
CCS8	79
CF16	109
CF2000LM/18	73
CF2000LM/22	73
CF2000LS/18	73
CF2000LS/22	73
CF2000LS/24	73
CF2000LSR/18	72
CF2000LSR/22	72
CF2000LSR/24	72
CL16	90
CL16Z	90
CL20	90
CL20Z	90
CL24	90
CL24/INOX	91
CL24Z	90
CL24ZD/N	90
CL34	91
CP/2028	106
CP/2040	107
CP/2048	107
CP/2050F	107
CP/2055F	107
CP/4530F	107
CP/5045F	107
CP/5050F	106
CP/7055F	107
CP/8065F	107
CP100	93
CP100Z	94
CP120	93

ART.	PAG.	ART.	PAG.	ART.	PAG.	ART.	PAG.
CP120Z	94	CPPT45	95	CS8	79	CVF/T400	88
CP150	93	CPPT50	95	CT10/Z-200	89	CVF/T500	88
CP150Z	94	CPPT60	95	CT10/Z-300	89	CVS/T150	88
CP175	93	CPPT80	95	CT10/Z-400	89	CVS/T200	88
CP175Z	94	CPR2030	94	CT11/Z-130	90	CVS/T250	88
CP20	93	CPR2030Z	94	CT11/Z-180	90	CVS/T300	88
CP200	93	CPR2040	94	CT11/Z-250	90	CVS/T400	88
CP200Z	94	CPR2040Z	94	CT5/180	89	CVS/T500	88
CP20Z	94	CPR3050	94	CT5/220	89	CW65	80
CP30	93	CPR3050Z	94	CT5/270	89	CW85	80
CP30Z	94	CPR3060	94	CT6/150	89	CWDS	80
CP40	93	CPR3060Z	94	CT6/200	89	DA10X30T/INOX	92
CP40Z	94	CPR4060	94	CT6/250	89	DA10X50T/INOX	92
CP50	93	CPR4060Z	94	CT7	79	DA17X15,5T/A2	92
CP50Z	94	CPR4080	94	CT8/B-50	89	DA17X15T/A2	92
CP60	93	CPR4080Z	94	CT8/B-70	89	DA8X30T/INOX	92
CP60Z	94	CPR50100	94	CT8/B-90	89	DA8X50T/INOX	92
CP80	93	CPR50100Z	94	CT8/Z-50	89	DGA30	103
CP80Z	94	CPS100	94	CT8/Z-70	89	DGA30Z	103
CPL100	93	CPS120	94	CT8/Z-90	89	DGA35	103
CPL120	93	CPS40	94	CT9/B-150	89	DGA35Z	103
CPL150	93	CPS70	94	CT9/B-200	89	DGB30	103
CPL200	93	CPS80	94	CT9/B-300	89	DGB30Z	103
CPL50	93	CPSI100	94	CT9/B-400	89	DGB34	103
CPL60	93	CPSI120	94	CT9/B-500	89	DGB34Z	103
CPL70	93	CPSI70	94	CT9/B-700	89	DGC35	104
CPL80	93	CPT101	93	CTS7	80	DGC35Z	104
CPP100	95	CPT101Z	93	CV10/130	87	DGCF35	104
CPP12	95	CPT114	93	CV10/300	87	DGCF35Z	104
CPP15	95	CPT114Z	93	CV10/T130	87	DGH35	104
CPP16	95	CPT30	93	CV10/T300	87	DGH35Z	104
CPP20	95	CPT30Z	93	CV10/T500	87	DGI35	105
CPP25	95	CPT33	93	CV1025/200	88	DGI35Z	105
CPP30	95	CPT33Z	93	CV1025/250	88	DGL	103
CPP35	95	CPT42	93	CV1025/300	88	DGL30	103
CPP40	95	CPT42Z	93	CV1025/400	88	DGL30Z	103
CPP50	95	CPT48	93	CV1025/500	88	DGLZ	103
CPP60	95	CPT48Z	93	CV1025/600	88	EGP10	60
CPP80	95	CPT60	93	CV14/330	88	EGP14	60
CPPR1530	95	CPT60Z	93	CV14/330T	88	G/AP65	66
CPPR2030	95	CPT76	93	CV14/660	88	G/AP65/3	66
CPPR2040	95	CPT76Z	93	CV14/660T	88	G/AP65G	66
CPPR2540	95	CPT90	93	CV16/150/INOX	90	G/AP65G/3	66
CPPR30100	95	CPT90Z	93	CV616/150	88	G/AP80	67
CPPR3040	95	CR22	64	CV616/200	88	G/AP80/3	67
CPPR3050	95	CR22ZF	64	CV616/250	88	G/AP80G	67
CPPR3060	95	CR2820P	64	CV616/300	88	G/AP80G/3	67
CPPT10	95	CR3012ZA	64	CV616/400	88	G/AP90	69
CPPT100	95	CR3012ZA/2	64	CV616/500	88	G/AP90/3	69
CPPT15	95	CR4430	74	CV9/50/INOX	90	G/AP90G	69
CPPT20	95	CR6040-C	75	CV9/70/INOX	90	G/AP90G/3	69
CPPT25	95	CR6547	74	CVF/T150	88	G10Z	8
CPPT30	95	CS102	82	CVF/T200	88	G10ZF	26
CPPT35	95	CS102/60	82	CVF/T250	88	G12A	12
CPPT40	95	CS2000LSR/24	77	CVF/T300	88	G12Z	12

ART.	PAG.
G12ZF	28
G14AX2	18
G14Z	18
G16VZ	22
G16Z	21
G8	1
G8I	1, 6, 11, 25, 27
G9Z	3
G9ZF	24
GIM	16, 29
GINEVRA	46
GINEVRA/3020	46
GINEVRA/40	46
GR153CE	60
GR153F	59
GR156CE	60
GR156F	59
GR193CE	60
GR193F	59
GR196CE	60
GR196F	59
GR283F	59
GR286F	59
IEL	86
LA2000	96
LANCILLOTTO	48
LB2000	96
LC2000/2	97
LD2000	96
LE2000/1	98
LE2000/2	98
LE2000/2P	98
LE2000/3	98
LE2000/3P	98
LE2000/4	98
LE2000/4P	98
LE2001/1	97
LE2001/2	97
LF2000/1	98
LF2000/2	98
LF2000/3	98
LF2000/4	98
LFA1	96
LFB1	96
LG2000/1	98
LG2000/2	98
LG2000/3	98
LG2000/4	98
LH2000/1	97
LH2000/2	97
LH2000/3	97
LH2000/4	97
LI2000/1	96
LI2000/2	96
LL2000/1	97

ART.	PAG.
LM2000/1	98
LM2000/2	98
LM2000/3	98
LN2000	98
LO2000	96
LO2000/1	96
LP2000/1	98
LP2000/2	98
LP2000/3	98
LP2000/4	98
LQ2000/2	97
LR2000	96
LS 120V	16
LS 40-120	16
LS2000	96
LT2000/1	97
LT2000/4	97
LV2000	97
LV2001	97
LX2000	96
LZ2000/1	97
LZ2000/2	97
LZ2000/3	97
M1	21
M102/1-C	84
M102/1-V	84
M102/2-C	84
M102/2-V	84
M102/3-C	84
M102/3-V	84
M102/4-C	84
M102/4-V	84
M102BN/2	84
M102B/2/B	84
M102B/2/M	84
M102B/2/V	84
M102BN70	84
M102B70/B	84
M102B70/M	84
M102B70/V	84
M102BNE	84
M102N	83
M102NQ7	83
M102PQ8	84
M102RQ7	84
M102RQ8	84
M1V	21
MB/D	80
MB/S	80
MC	107
MCC/D	108
MCC/S	108
MCC67	83
MCF/D	108
MCF/S	108

ART.	PAG.
MERLINO	46
MERLINO/3020	46
MERLINO/40	46
MGC/308	85
MGD/308	85
MID	85
MIG	85
MIP	85
MPC/180	85
MPC/230	85
MPD/180	85
MPD/230	85
MV1	22
MV1A	22
MV1AA	22
MV1L	23
O/D12	102
O/D120	102
O/D14	102
O/D16	102
O/D18	102
O/DS12	102
O/DS14	102
O/DSOT12	106
O/DSOT14	106
O/DV12	102
O/DV14	102
O/DX10	102
O/DX12	102
O/DXOT12	106
O/DXOTL10	106
O/DXOTL12	106
O/M12	101
O/M12Q	100
O/M14	101
O/M14Q	100
O/M16	101
O/M16Q	100
O/M18	101
O/M20	101
O/MQ12Q	99
O/MQ12QA	100
O/MQ14Q	99
O/MQ14QA	100
O/MQ16Q	99
O/MQ16QA	100
O/P12	100
O/P12F	101
O/P12Q	100
O/P14	100
O/P14F	101
O/P14G	51
O/P14Q	100
O/P16	100
O/P16F	101

ART.	PAG.
O/POT14	105
O/Q12Q	99
O/Q12QA	100
O/Q14Q	99
O/Q14QA	100
O/Q16Q	99
O/Q16QA	100
O/S12	102
O/S14	102
O/S16	102
O/S18	102
O/SS12	102
O/SS14	102
O/SV12	102
O/SV14	102
O/SX10	102
O/SX12	102
O/SXOTL10	106
O/SXOTL12	106
O2000/B35X27	62
O2000/CN26X40	61
O2000/CN30X35	61
O2000/CN40X45	61
O2000/CN40X60	61
O2000/CNX32X40	61
O2000/CNX40X40	61
O2000/CO30X35	61
O2000/CO40X45	61
O2000/CO40X60	61
O2000/TC30	61
O2000B/38X27	62
OD/M12	101
OD/M12Q	100
OD/M14	101
OD/M14Q	100
OD/M16	101
OD/M16Q	100
OD/M18	101
OD/M20	101
OD/P12	100
OD/P12F	101
OD/P12Q	100
OD/P14	100
OD/P14F	101
OD/P14G	51
OD/P14Q	100
OD/P16	100
OD/P16F	101
OD/POT14	105
OD/Q12Q	99
OD/Q12QA	100
OD/Q14Q	99
OD/Q14QA	100
OD/Q16Q	99
OD/Q16QA	100

ART.	PAG.
P10	45
P11	45
P16	45
P20	45
P2000/30S	76
P2000/30SP	77
P2000/40S	76
P2000/40SP	77
P2000/50	76
P2000/50P	76
P2000/50S	76
P2000/50SP	76
P2000/65	76
P2000/65P	76
P2000/65S	76
P2000/65SP	76
P2000I/50	76
P8	45
P9	45
PA28/10-6	92
PA28/12-8	92
PA28/14-10	92
PA28/16-12	92
PA28/18-14	92
PA28/20-16	92
PA28/22-18	92
PA28/24-20	92
PA28/25-22	92
PAM	87
PAM/Z	87
PB/18	74
PB/22	74
PC16	81
PC21	81
PCH15	45
PCH15/10	45
PCI/18	73
PCI/22	73
PCI/24	73
PCS/18	73
PCS/22	73
PCS/24	73
PG10	107
PG12	107
PG14	107
PG16	107
PI3012	64
PI3012A	65
PIAS/AP6580	66, 68
PIAS/AP90	69
PIAS/CF	108
PIAS/Q25F	108
PIAS/Q30F	108
PIAS01	45

ART.	PAG.
PIAS60/CF	108
PIAS60/Q25F	108
PIAS60/Q30F	108
PIF/18	74
PIF/22	74
PIM	87
PIM/Z	87
PIP/18	74
PIP/22	74
PIS/18	74
PIS/22	74
PL350	87
PL450	87
PL600	87
PL700	87
PLP500	87
PLP700	87
PO12Q	107
PO18T	107
PR/18	73
PR/20	73
PR/22	73
PR/24	73
R12001/R-100	53
R12001/R-80	53
R12001/T-100	53
R12001/T-80	53
R12002/R-140	54
R12002/T-140	54
R12004/R-100	56
R12004/R-80	56
R12004/T-100	56
R12004/T-80	56
R2001/R-100	52
R2001/R-120	52
R2001/R-140	52
R2001/R-160	52
R2001/R-180	52
R2001/R-200	52
R2001/R-40	52
R2001/R-50	52
R2001/R-60	52
R2001/R-70	52
R2001/R-80	52
R2001/R-90	52
R2001/T-100	52
R2001/T-120	52
R2001/T-140	52
R2001/T-160	52
R2001/T-180	52
R2001/T-200	52
R2001/T-50	52
R2001/T-60	52
R2001/T-70	52
R2001/T-80	52

ART.	PAG.
R2001/T-90	52
R2001/V-100	52
R2001/V-120	52
R2001/V-140	52
R2001/V-160	52
R2001/V-180	52
R2001/V-200	52
R2001/V-40	52
R2001/V-50	52
R2001/V-60	52
R2001/V-70	52
R2001/V-80	52
R2001/V-90	52
R2002/R-100	53
R2002/R-120	53
R2002/R-140	53
R2002/R-160	53
R2002/R-180	53
R2002/R-200	53
R2002/R-80	53
R2002/R-90	53
R2002/T-100	53
R2002/T-120	53
R2002/T-140	53
R2002/T-160	53
R2002/T-180	53
R2002/T-200	53
R2002/T-80	53
R2002/T-90	53
R2002/V-100	53
R2002/V-120	53
R2002/V-140	53
R2002/V-160	53
R2002/V-180	53
R2002/V-200	53
R2002/V-80	53
R2002/V-90	53
R2003/R-100	55
R2003/R-50	55
R2003/R-60	55
R2003/R-70	55
R2003/R-80	55
R2003/R-90	55
R2003/T-100	55
R2003/T-50	55
R2003/T-60	55
R2003/T-70	55
R2003/T-80	55
R2003/T-90	55
R2003/V-100	55
R2003/V-50	55
R2003/V-60	55
R2003/V-70	55
R2003/V-80	55
R2003/V-90	55

ART.	PAG.
R2004/R-100	56
R2004/R-120	56
R2004/R-140	56
R2004/R-50	56
R2004/R-60	56
R2004/R-70	56
R2004/R-80	56
R2004/R-90	56
R2004/T-100	56
R2004/T-120	56
R2004/T-140	56
R2004/T-50	56
R2004/T-60	56
R2004/T-70	56
R2004/T-80	56
R2004/T-90	56
R2004/V-100	56
R2004/V-120	56
R2004/V-140	56
R2004/V-50	56
R2004/V-60	56
R2004/V-70	56
R2004/V-80	56
R2004/V-90	56
R2005/R-100	57
R2005/R-120	57
R2005/R-140	57
R2005/R-90	57
R2005/T-100	57
R2005/T-120	57
R2005/T-140	57
R2005/T-90	57
R2005/V-100	57
R2005/V-120	57
R2005/V-140	57
R2005/V-90	57
R2006/R-100	57
R2006/R-120	57
R2006/R-140	57
R2006/R-70	57
R2006/R-80	57
R2006/R-90	57
R2006/T-100	57
R2006/T-120	57
R2006/T-140	57
R2006/T-70	57
R2006/T-80	57
R2006/T-90	57
R2006/V-100	57
R2006/V-120	57
R2006/V-140	57
R2006/V-70	57
R2006/V-80	57
R2006/V-90	57
R2007/R-100	58

ART.	PAG.	ART.	PAG.	ART.	PAG.	ART.	PAG.
R2007/R-120	58	R2013/R-60	55	S102/60	82	SO2000/B4	62
R2007/R-140	58	R2013/R-80	55	S102/60E	82	SO2000/C2	62
R2007/R-80	58	R2501/R-100	52	S174/40	83	SO2000/C4	62
R2007/R-90	58	R2501/R-80	52	S174/45	83	SO2001	63
R2007/T-100	58	R2501/T-100	52	S174/50	83	SO2001//INOX	63
R2007/T-120	58	R2501/T-120	52	S1RMS	19	SO2002	63
R2007/T-140	58	R2501/T-140	52	S204/33	83	SSA	83
R2007/T-80	58	R2501/T-80	52	S204/33//INOX	83	SSB	83
R2007/T-90	58	R2501/V-100	52	S2RM	13	STS303MSZ	13
R2007/V-100	58	R2501/V-120	52	S2RMG	13	SV1	18
R2007/V-120	58	R2501/V-140	52	S2RPP	12	SV1A	18
R2007/V-140	58	R2501/V-80	52	S2RPPS	12	SV1A/O	18
R2007/V-80	58	RCB	78	S4MLI	14	SV1L	19
R2007/V-90	58	RGS2000/42	63	S4RM	13	SV1L2	14
R2008/R-100	54	RGS2000/52	63	S4RMG	13	SV1LA	19
R2008/R-120	54	RN2001/R-100	53	S4RPP	12	SV1LA/O	19
R2008/R-140	54	RN2001/R-120	53	S4RPPS	13	SV1S	19
R2008/R-160	54	RN2001/R-60	53	SET 4RM	16	SV2S	19
R2008/R-80	54	RN2001/R-80	53	SET MORGANA	49	T7	79
R2008/R-90	54	RN2001/V-100	53	SET MORGANA/2	49	T7//INOX	79
R2008/T-100	54	RN2001/V-120	53	SET MORGANA/4	49	TAP/65	67
R2008/T-120	54	RN2001/V-60	53	SET MORGANA/S	49	TAP/65R	67
R2008/T-140	54	RN2003/R-100	55	SET MORGANA/S2	49	TAP/80	68
R2008/T-160	54	RN2003/R-80	55	SET MORGANA/S4	49	TAP/80R	68
R2008/T-80	54	RN2003/V-100	55	SET S4RM	16	TAP/90R	70
R2008/T-90	54	RN2003/V-80	55	SF/32OT	109	TC10	44
R2008/V-100	54	RN2004/R-100	56	SF/32OT14	109	TC12	44
R2008/V-120	54	RN2004/R-120	56	SF/49OT	109	TC14	44
R2008/V-140	54	RN2004/R-80	56	SF100	109	TCS/18-30	73
R2008/V-160	54	RN2004/V-100	56	SF15	109	TCS/18-35	74
R2008/V-80	54	RN2004/V-120	56	SF20	109	TCS/22-35	73
R2008/V-90	54	RN2004/V-80	56	SF20S	109	TCS/22-40	74
R2009/R-100	54	RN2006/R-100	57	SF20T	109	TCS/24-40	73
R2009/R-120	54	RN2006/R-120	57	SF25	109	TCS/24-50	74
R2009/R-140	54	RN2006/R-80	57	SF25S	109	TIR/16	66, 68
R2009/R-160	54	RN2006/V-100	57	SF25T	109	TIR/18	69
R2009/R-180	54	RN2006/V-120	57	SF30	109	TS7	80
R2009/R-200	54	RN2006/V-80	57	SF30S	109	V1	18
R2009/R-250	54	RO/P13	92	SF30T	109	V1L	19
R2009/R-80	54	RO/P15	92	SF35	109	V1L2	14
R2009/T-100	54	RO/P17	92	SF40	109	V1LA	19
R2009/T-120	54	RO/P19	92	SF50	109	V1LA/O	19
R2009/T-140	54	RO100	44	SF50S	109	V1S	19
R2009/T-160	54	RO1100	44	SF50T	109	V2	14
R2009/T-180	54	RO1150	44	SF60	109	V2L	14
R2009/T-200	54	RO120/140	44	SF70	109	V2S	19
R2009/T-250	54	RO1500	44	SF80	109	VCF/10	91
R2009/V-100	54	RO40/60	44	SF90	109	VCF/12	91
R2009/V-120	54	RO80	44	SM1	21	VF/10	91
R2009/V-140	54	S102/30	82	SM1V	21	VF/12	91
R2009/V-160	54	S102/35	82	SMV1	22	VIA	18
R2009/V-180	54	S102/40	82	SMV1A	22	VIA/O	18
R2009/V-200	54	S102/45	82	SMV1AA	22	VN/10	91
R2009/V-250	54	S102/50	82	SO2000/AP2	67, 68, 70	VN/12	91
R2009/V-80	54	S102/54AE	83	SO2000/B2	62		



PETTITI GIUSEPPE s.p.a.

SERIE MAGNUM

PORTATA	Per coppia di carrelli
CAPACITY	For each pair of trolleys
CAPACIDAD	Por par de carriles
PORTEE	Pour couple de chariots
Kg 1000	a 4 cuscinetti with 4 bearings con 4 cojinetes a 4 coussinets

CARRELLI ED ACCESSORI PER MONOROTAIA G8

TROLLEYS AND ACCESSORIES FOR RAIL G8

CARRILES Y ACCESORIOS PARA MONORRIEL G8

CHARIOTS ET ACCESSOIRES POUR MONORAIL G8

MONOROTAIA IN ACCIAIO GREZZO

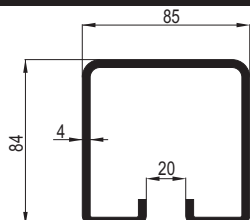

Lunghezza = 6 m
Length = 6 m
Largo = 6 m
Longueur = 6 m

Rail in steel.

Monorriel de acero.

Monorail en acier.

ART.	Confez. Box	Peso Kg Weight
G8	36 m n° 6x6 m	Kg/m 9,680

CARRELLO CENTRALE A 4 RUOTE

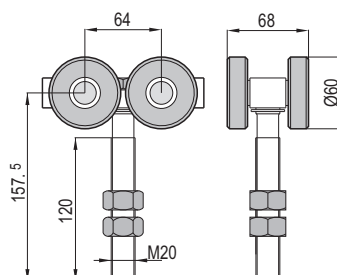

Central trolley with 4 wheels.

Carril centrado con 4 ruedas.

Chariot coulissant à 4 roulements.

4RMA	Fisso - cuscinetti in acciaio Fix - steel bearings Fijo - cojinetes de acero Fixe - coussinets en acier
-------------	--

ART.	Confez. Box	Peso Kg Weight
4RMA	6	2,400

PIASTRA FISSA CON OLIVA GIREVOLE IN OTTONE

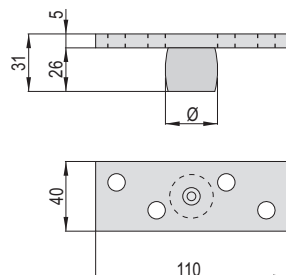
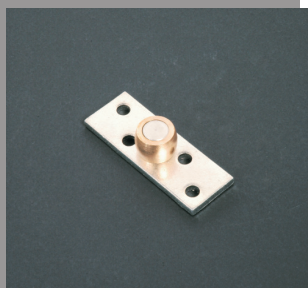

Fix plate with rotating brass olive.

Plancha fija con oliva giratoria de latón.

Platine fixe avec olive pivotante en laiton.

ART.	Ø	Confez. Box	Peso Kg Weight
309/25	25	25	0,270
309/30	30	25	0,310

FERMO DI ARRESTO CON PARACOLPO IN GOMMA

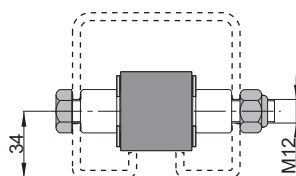

Back stop with rubber buffer.

Tope de detención con amortiguador de goma.

Ferme d'arrêt avec butoir en gomme .

ART.	Confez. Box	Peso Kg Weight
4100	6	0,330

GUIDA INFERIORE IN ACCIAIO ZINCATO

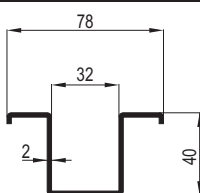

Lunghezza = 6 m
Length = 6 m
Largo = 6 m
Longueur = 6 m

Lower guide in zinked steel.

Guía inferior de acero galvanizado.

Guide inferieure en acier zingue.

ART.	Confez. Box	Peso Kg Weight
G8I	36 m n° 6x6 m	Kg/m 2,730

ATTACCO LATERALE REGISTRABILE

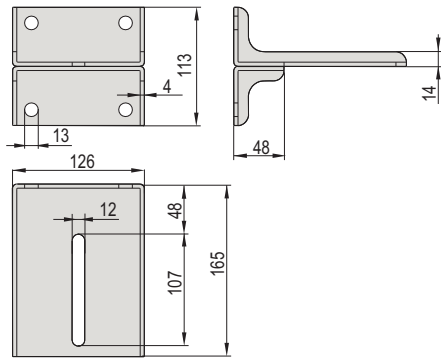

Adjustable support for rail G8.

Soporte regulable para G8.

Bride pour rail G8 avec réglage.

ART.	Confz. Box	Peso Kg Weight
ALG8	4	1,300

Esempio di applicazione con scorrimento lineare.
L'applicazione è valida per le serie **Magnum, Sempione e Frejus**.

Application example with linear sliding.
The application is valid for **Magnum, Sempione and Frejus** series.

Ejemplo de aplicación con rodamiento lineal.
La aplicación es válida para las series **Magnum, Sempione y Frejus**.

Exemple d'application avec roulement linéaire.
L'application est valide pour les séries **Magnum, Sempione et Frejus**.

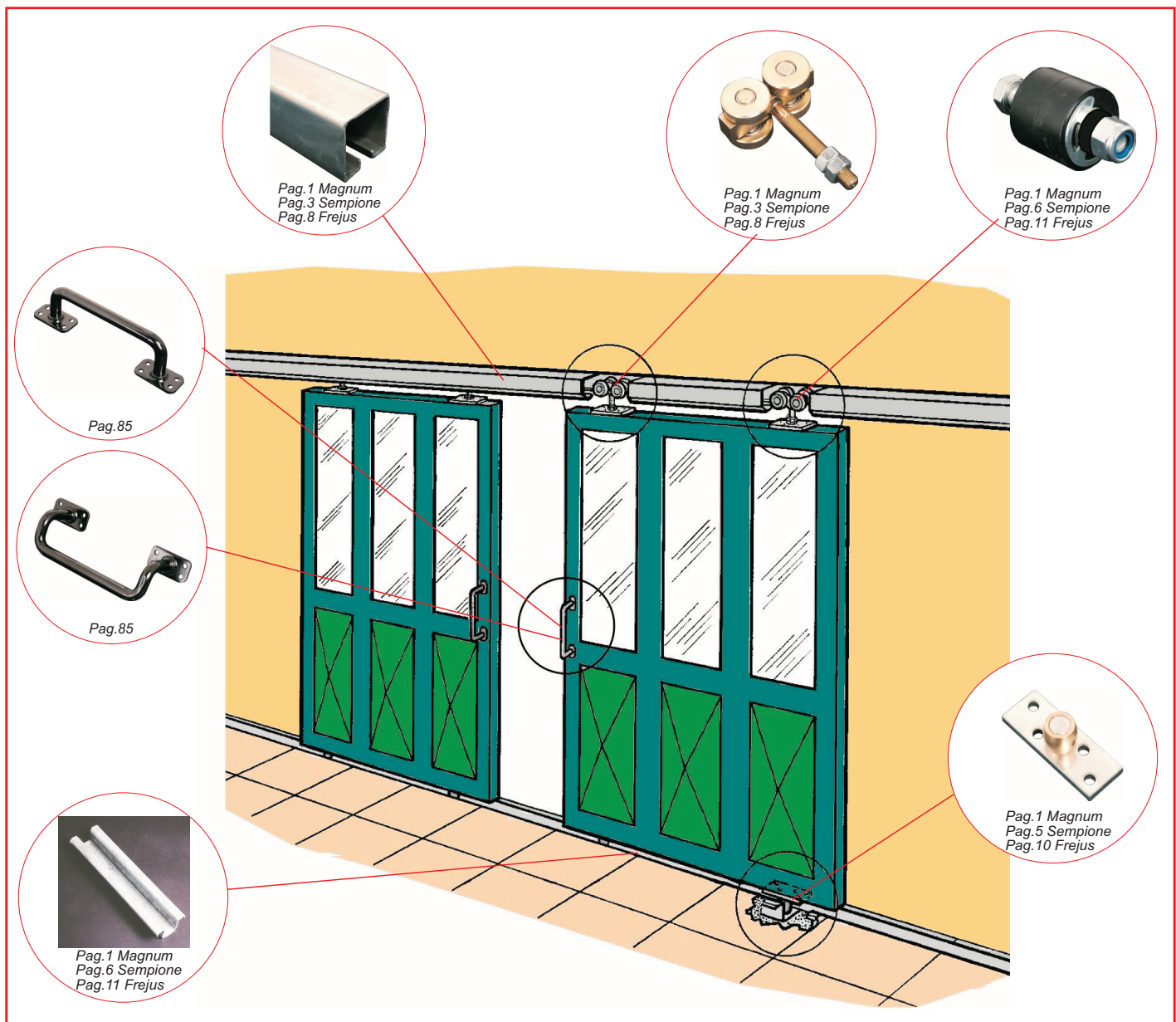



PETTITI GIUSEPPE s.p.a.

SERIE SEMPIONE

PORTATA CAPACITY CAPACIDAD PORTEE	Per coppia di carrelli For each pair of trolleys Pour couple de chariots Pour couple de chariots
Kg 400	a 2 cuscinetti with 2 bearings de 2 cojinetes a 2 coussinets
Kg 750	a 4 cuscinetti with 4 bearings de 4 cojinetes a 4 coussinets

CARRELLI ED ACCESSORI PER MONOROTAIA G9Z

TROLLEYS AND ACCESSORIES FOR RAIL G9Z

CARRILES Y ACCESORIOS PARA MONORRIEL G9Z

CHARIOTS ET ACCESSOIRES POUR MONORAIL G9Z

MONOROTAIA IN ACCIAIO ZINCATO

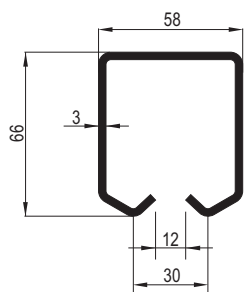
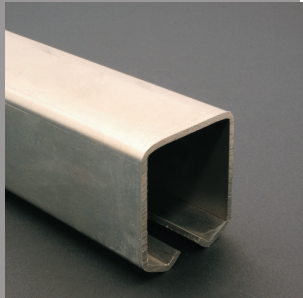

Lunghezza = 6 m
Length = 6 m
Largo = 6 m
Longueur = 6 m

Zinked steel rail.

Monorriel de acero galvanizado .

Monorail en acier zingue .

ART.	Confez. Box	Peso Kg Weight
G9Z	36 m n° 6x6 m	Kg/m 4,980

CARRELLO FISSO A 2 RUOTE

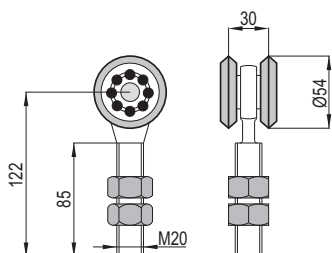

Fix trolley with 2 wheels.

Carro fijo con 2 ruedas .

Chariot fixe a 2 roulements.

2RG	Fisso - cuscinetti cementati Fix - cemented bearings Fijo - cojinetes cementados Fixe - coussinets cements
2RG/C	Fisso - cuscinetti zincati Fix - zinked bearings Fijo - cojinetes galvanizados Fixe - coussinets zingue

ART.	Confez. Box	Peso Kg Weight
2RG	8	0,750
2RG/C	8	0,750

CARRELLO FISSO A 4 RUOTE

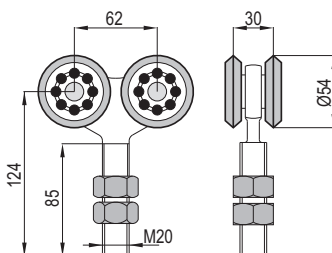

Fix trolley with 4 wheels .

Carro fijo con 4 ruedas .

Chariot fixe à 4 roulements.

4RG	Fisso - cuscinetti cementati Fix - cemented bearings Fijo - cojinetes cementados Fixe - coussinets cements
4RG/C	Fisso - cuscinetti zincati Fix - zinked bearings Fijo - cojinetes galvanizados Fixe - coussinets zingue

ART.	Confez. Box	Peso Kg Weight
4RG	4	1,250
4RG/C	4	1,250

CARRELLO FISSO A 2 RUOTE CON CUSCINETTI

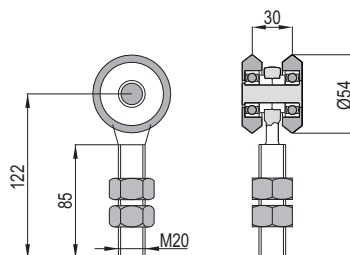

Fix trolley with 2 wheels with bearings .

Carro fijo con 2 ruedas con cojinetes .

Chariot fixe à 2 roulements avec coussinets.

2RG/CU	Fisso - con cuscinetti Fix - with bearings Fijo - con cojinetes Fixe - avec des coussinets
---------------	---

ART.	Confez. Box	Peso Kg Weight
2RG/CU	8	0,750

CARRELLO FISSO A 4 RUOTE CON CUSCINETTI

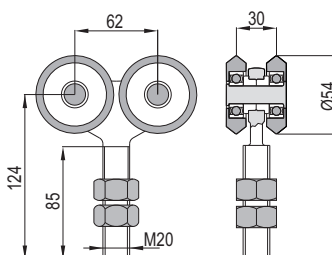

Fix trolley with 4 wheels with bearings .

Carro fijo con 4 ruedas con cojinetes .

Chariot fixe à 4 roulements avec coussinets.

4RG/CU	Fisso - con cuscinetti Fix - with bearings Fijo - con cojinetes Fixe - avec des coussinets
---------------	---

ART.	Confez. Box	Peso Kg Weight
4RG/CU	4	1,250

CARRELLO GIREVOLE A 2 RUOTE

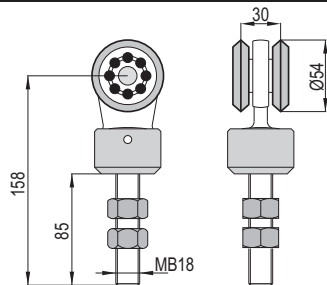

Rotating trolley with 2 wheels .

Carro giratorio con 2 ruedas .

Chariot pivotant à 2 roulements.

2RGS

Girevole - con cuscinetti cementati
Slewing - with cemented bearings
Giratorio - con cojinetes cementados
Pivotant - coussinets cements

ART.

Confez. Box

Peso Kg Weight

2RGS

6

1,250

CARRELLO GIREVOLE A 4 RUOTE

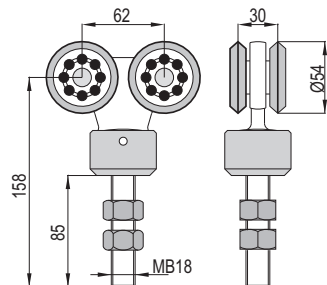

Rotating trolley with 4 wheels .

Carro giratorio con 4 ruedas .

Chariot pivotant à 4 roulements.

4RGS

Girevole - con cuscinetti cementati
Slewing - with cemented bearings
Giratorio - con cojinetes cementados
Pivotant - coussinets cements

ART.

Confez. Box

Peso Kg Weight

4RGS

4

1,800

CARRELLO FISSO A 2 RUOTE CON CERNIERA

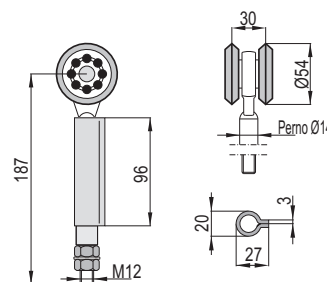

Fix trolley with 2 wheels , and hinge .

Carro fijo con 2 ruedas , y bisagra .

Chariot fixe à 2 roulements , avec charniere.

2RGM

Fisso - cuscinetti cementati
Fix - cemented bearings
Fijo - cojinetes cementados
Fixe - coussinets cements

ART.

Confez. Box

Peso Kg Weight

2RGM

12

0,820

CARRELLO FISSO A 4 RUOTE CON CERNIERA

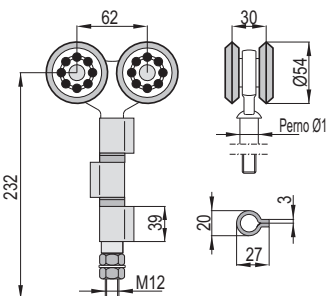

Fix trolley with 4 wheels , and hinge .

Carro fijo con 4 ruedas , y bisagra .

Chariot fixe à 4 roulements , avec charniere.

4RGM

Fisso - cuscinetti cementati
Fix - cemented bearings
Fijo - cojinetes cementados
Fixe - coussinets cements

ART.

Confez. Box

Peso Kg Weight

4RGM

6

1,420

CARRELLO LATERALE A 4 RUOTE CON CERNIERA

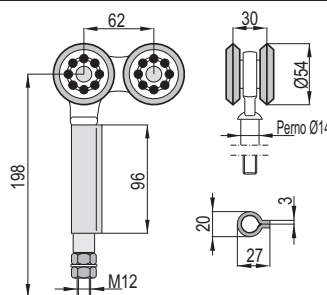

Lateral trolley with 4 wheels , and hinge .

Carro lateral con 4 ruedas , y bisagra .

Chariot à 4 roulements , avec charniere.

4RGMT

Fisso - cuscinetti cementati
Fix - cemented bearings
Fijo - cojinetes cementados
Fixe - coussinets cements

ART.

Confez. Box

Peso Kg Weight

4RGMT

6

1,380

PERNO GUIDA INFERIORE CON OLIVA E CERNIERA

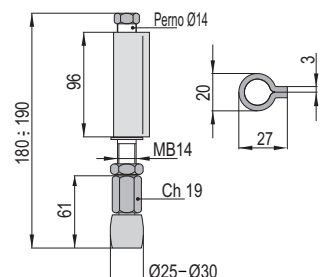

Lower guide pin with olive and hinge .

Perno guia inferior con oliva , y bisagra .

Pivot guide inferieur avec olive et charniere .

ART.

Confez. Box

Peso Kg Weight

309M-25

20

0,460

309M-30

20

0,500

PERNO GUIDA INFERIORE CON OLIVA E CERNIERA

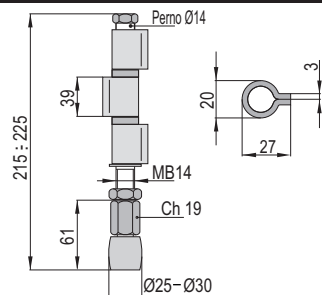

Lower guide pin with olive and hinge .

Perno guía inferior con oliva ,y bisagra .

Pivot guide inferieur avec olive et charniere .

ART.	Confez. Box	Peso Kg Weight
309M/3-25	20	0,540
309M/3-30	20	0,580

CERNIERA A 3 ALI SU CUSCINETTI REGGISPINTA CEMENTATI

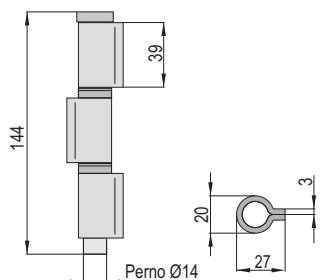

Hinge with 3 wings, on thrust cemented bearings .

Bisagra con 3 alas sobre cojinetes cementados.

Charnière à 3 ailes, sur roulements cementés.

ART.	Confez. Box	Peso Kg Weight
1700/3C	10	0,370

PIASTRA GIREVOLE SU SFERE

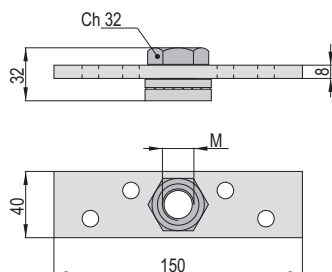
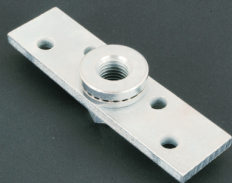

Rotating plate on thrust spheres.

Plancha giratoia a sobre bolas.

Platine articulee sur billes.

ART.	M	Confez. Box	Peso Kg Weight
209S	20	20	0,460
209S/18	18	20	0,460

PIASTRA FISSA CON OLIVA GIREVOLE IN OTTONE

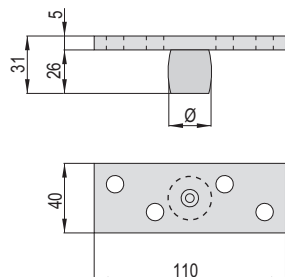

Fix plate with rotating brass olive.

Plancha fija con oliva giratoria de latón.

Platine fixe avec olive articulée en laiton.

ART.	Ø	Confez. Box	Peso Kg Weight
309/25	25	25	0,270
309/30	30	25	0,310

PERNO GUIDA CON OLIVA IN OTTONE

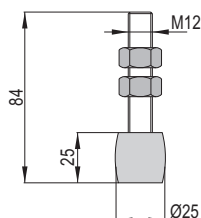

Guide pin with brass olive .

Perno guía con oliva de latón.

Pivot guide avec olive en laiton .

ART.	Confez. Box	Peso Kg Weight
311P	50	0,150

DEVIATORE CON RULLO DI GUIDA

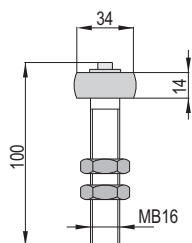

Guide pin with roller .

Perno guía con rodillo en laton .

Deviateur avec rouleau de guide .

ART.	Confez. Box	Peso Kg Weight
309D	25	0,240



FERMO DI ARRESTO CON PARACOLPO IN GOMMA

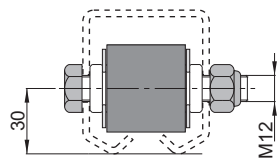

Back stop with rubber buffer.

Tope de detención con amortiguador de goma.

Ferme d'arrêt avec butoir en gomme .

ART.	Confez. Box	Peso Kg Weight
475	6	0,250

BLOCCHETTO GUIDA

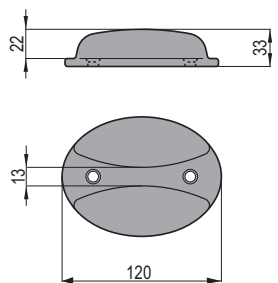

Meeting point.

Tope guía.

Bloc guide.

ART.	Confez. Box	Peso Kg Weight
BG/2000	12	1,370

ATTACCO LATERALE A FASCIA REGISTRABILE

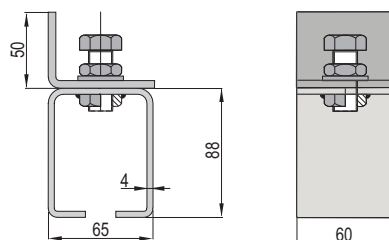

Lateral adjustable support.

Soporte lateral regulable.

Support lateral avec réglage.

ART.	Confez. Box	Peso Kg Weight
ALG9	10	0,700

ATTACCO A SOFFITTO A FASCIA REGISTRABILE

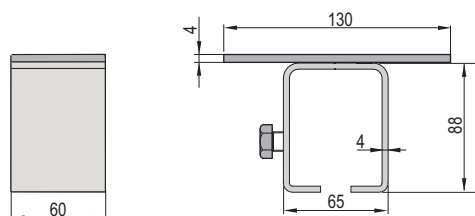

Adjustable support.

Soporte ou de techo, regulable.

Support pour plafond avec réglage.

ART.	Confez. Box	Peso Kg Weight
ASG9	10	0,750

GUIDA INFERIORE IN ACCIAIO

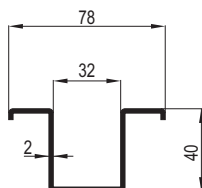

Lunghezza = 6 m

Length = 6 m

Longueur = 6 m

Longueur = 6 m

Lower guide in steel.

Guía inferior de acero .

Rail guide inferieur en acier.

ART.	Confez. Box	Peso Kg Weight
G8I	36 m n° 6x6 m	Kg/m 2,730

Esempio di applicazione per ante a libro.
L'applicazione è valida per le serie Sempione e Frejus.

Application example for folding wings.
The application is valid for Sempione and Frejus series.

Ejemplo de aplicación para hojas a libro.
La aplicación es válida para las series Sempione y Frejus.

Exemple d'application pour vantaux pliantes.
L'application est valide pour les séries Sempione et Frejus.





PETTITI GIUSEPPE s.p.a.

SERIE FREJUS

PORTATA CAPACITY CAPACIDAD PORTEE	Per coppia di carrelli For each pair of trolleys Pour couple de chariots a 2 cuscinetti with 2 bearings de 2 cojinetes a 2 coussinets
Kg 200	a 4 cuscinetti with 4 bearings de 4 cojinetes a 4 coussinets
Kg 650	

CARRELLI ED ACCESSORI PER MONOROTAIA G10Z

TROLLEYS AND ACCESSORIES FOR RAIL G10Z

CARRILES Y ACCESORIOS PARA MONORRIEL G10Z

CHARIOTS ET ACCESSOIRES POUR MONORAIL G10Z

MONOROTAIA IN ACCIAIO ZINCATO

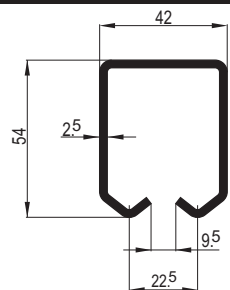
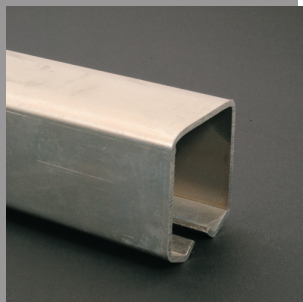

Lunghezza = 6 m
Length = 6 m
Largo = 6 m
Longueur = 6 m

Rail in zinked steel.

Monorriel de acero galvanizado .

Monorail en acier zingue .

ART.	Confez. Box	Peso Kg Weight
G10Z	24 m n° 4x6 m	Kg/m 3,200

CARRELLO FISSO A 2 RUOTE

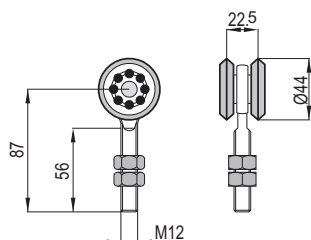

Fix trolley with 2 wheels.

Carro fijo con 2 ruedas.

Chariot fixe à 2 roulements.

2RP	Fisso - cuscinetti cementati Fix - cemented bearings Fijo - cojinetes cementados Fixe - coussinets cements	
2RP/C	Fisso - cuscinetti zincati Fix - zinked bearings Fijo - cojinetes galvanizado Fixe - coussinets zingue	
ART.	Confez. Box	Peso Kg Weight
2RP	20	0,290
2RP/C	20	0,290

CARRELLO FISSO A 4 RUOTE

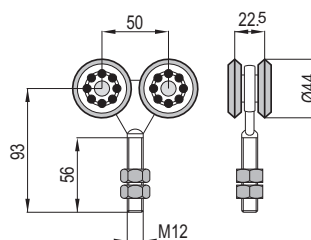

Fix trolley with 4 wheels .

Carro fijo con 4 ruedas .

Chariot fixe à 4 roulements.

4RP	Fisso - cuscinetti cementati Fix - cemented bearings Fijo - cojinetes cementados Fixe - coussinets cements	
4RP/C	Fisso - cuscinetti zincati Fix - zinked bearings Fijo - cojinetes galvanizado Fixe - coussinets zingue	
ART.	Confez. Box	Peso Kg Weight
4RP	10	0,550
4RP/C	10	0,540

CARRELLO FISSO A 2 RUOTE CON CUSCINETTI

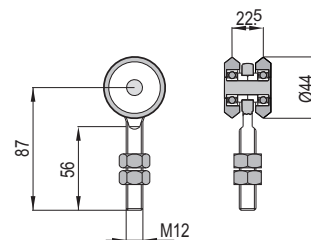
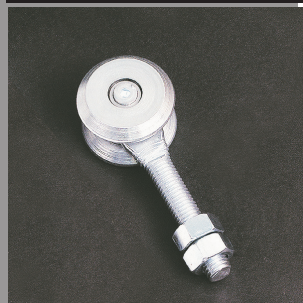

Fix trolley with 2 wheels with bearings.

Carro fijo con 2 ruedas con cojinetes .

Chariot fixe à 2 roulements avec coussinets.

2RP/CU	Fisso - con cuscinetti Fix - with bearings Fijo - con cojinetes Fixe - avec des coussinets	
ART.	Confez. Box	Peso Kg Weight
2RP/CU	8	0,290

CARRELLO FISSO A 4 RUOTE CON CUSCINETTI

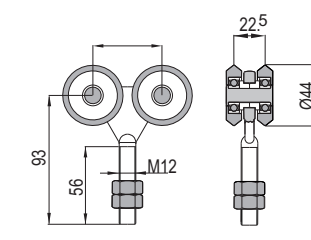

Fix trolley with 4 wheels with bearings.

Carro fijo con 4 ruedas con cojinetes .

Chariot fixe à 4 roulements avec coussinets.

4RP/CU	Fisso - con cuscinetti Fix - with bearings Fijo - con cojinetes Fixe - avec des coussinets	
ART.	Confez. Box	Peso Kg Weight
4RP/CU	4	0,550

CARRELLO GIREVOLE A 2 RUOTE

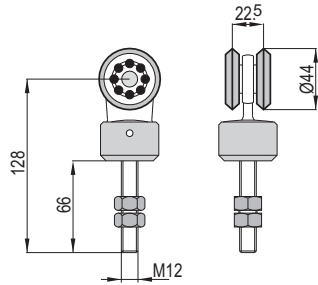

Rotating trolley with 2 wheels .

Carro giratorio con 2 ruedas .

Chariot pivotant à 2 roulements

2RPS

Girevole - con cuscinetti cementati
Slewing - with cemented bearings
Giratorio - con cojinetes cementados
Pivotant - coussinets cements

ART.

Confez.

Peso Kg

Box

Weight

2RPS

10

0,580

CARRELLO GIREVOLE A 4 RUOTE

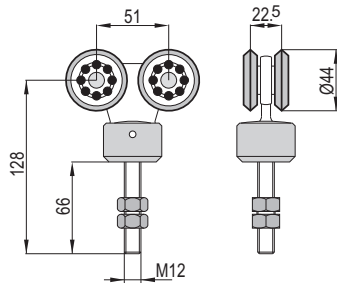

Rotating trolley with 4 wheels .

Carro giratorio con 4 ruedas .

Chariot pivotant à 4 roulements.

4RPS

Girevole - con cuscinetti cementati
Slewing - with cemented bearings
Giratorio - con cojinetes cementados
Pivotant - coussinets cements

ART.

Confez.

Peso Kg

Box

Weight

4RPS

6

0,900

CARRELLO FISSO A 2 RUOTE CON CERNIERA

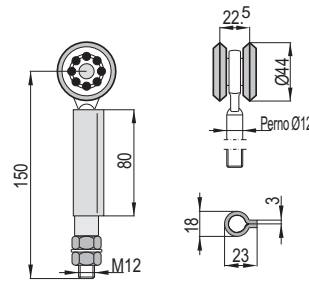

Fix trolley with 2 wheels , and hinge .

Carro fijo con 2 ruedas , y bisagra .

Chariot fixe à 2 roulements , avec charniere.

2RPM

Fisso - cuscinetti cementati
Fix - cemented bearings
Fijo - cojinetes cementados
Fixe - coussinets cements

ART.

Confez.

Peso Kg

Box

Weight

2RPM

20

0,470

CARRELLO FISSO A 4 RUOTE CON CERNIERA

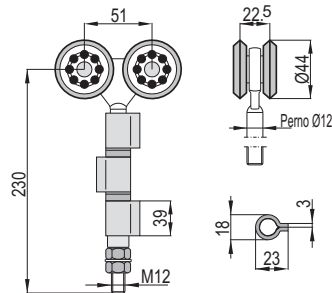

Fix trolley with 4 wheels , and hinge .

Carro fijo con 4 ruedas , y bisagra .

Chariot fixe à 4 roulements , avec charniere.

4RPM

Fisso - cuscinetti cementati
Fix - cemented bearings
Fijo - cojinetes cementados
Fixe - coussinets cements

ART.

Confez.

Peso Kg

Box

Weight

4RPM

12

0,830

CARRELLO LATERALE A 4 RUOTE CON CERNIERA

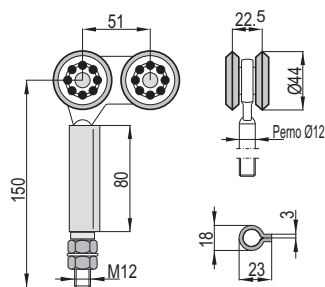

Lateral trolley with 4 wheels , with hinge.

Carro lateral con 4 ruedas , y bisagra .

Chariot laterale à 4 roulements , avec charniere.

4RPMT

Fisso - cuscinetti cementati
Fix - cemented bearings
Fijo - cojinetes cementados
Fixe - coussinets cements

ART.

Confez.

Peso Kg

Box

Weight

4RPMT

10

0,470

PERNO GUIDA INFERIORE CON OLIVA E CERNIERA

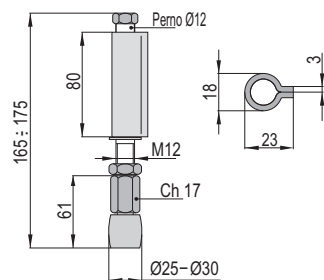

Lower guide pin with olive and hinge .

Perno guía inferior con oliva , y bisagra .

Pivot guide inferieur avec olive et charniere .

ART.

Confez.

Peso Kg

Box

Weight

310M-25

25

0,340

310M-30

25

0,380



PERNO GUIDA INFERIORE CON OLIVA E CERNIERA

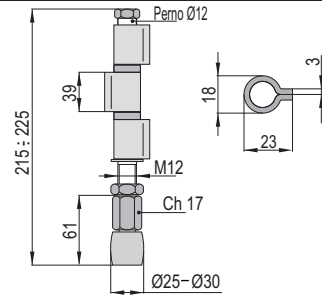

Lower guide pin with olive and hinge .

Perno guía inferior con oliva ,y bisagra .

Pivot guide inférieur avec olive et charnière .

ART.	Confez. Box	Peso Kg Weight
310M/3-25	25	0,440
310M/3-30	25	0,480

CERNIERA A 3 ALI SU CUSCINETTI REGGISPINTA CEMENTATI

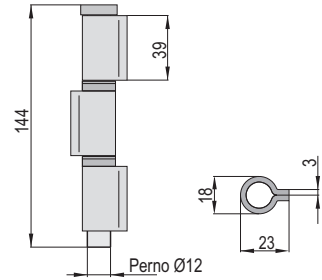

Hinge with 3 short wings, on thrust cemented bearings .

Bisagra con 3 alas cortas sobre cojinetes cementados.

Charnière en acier à 3 ailes courtes, sur roulements cémentés.

ART.	Confez. Box	Peso Kg Weight
1750/3C	10	0,280

PIASTRA GIREVOLE SU SFERE

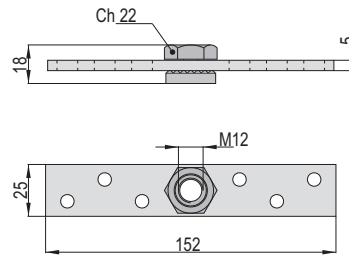

Rotating plate on balls.

Plancha giratoria a sobre bolas.

Platine articulée sur billes.

ART.	Confez. Box	Peso Kg Weight
210S	50	0,170

PIASTRA FISSA CON OLIVA GIREVOLE IN OTTONE

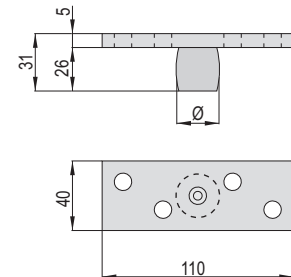

Fix plate with rotating olive in brass.

Plancha fija con oliva giratoria de latón.

Platine fixe avec olive articulée en laiton.

ART.	Ø	Confez. Box	Peso Kg Weight
309/25	25	25	0,270
309/30	30	25	0,310

PERNO GUIDA CON OLIVA IN OTTONE

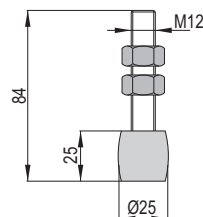

Guide pin with olive in brass.

Perno guía con oliva de latón.

Pivot guide avec olive en laiton .

ART.	Confez. Box	Peso Kg Weight
311P	50	0,150

DEVIATORE CON RULLO DI GUIDA

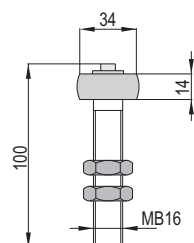

Guide pin with roller .

Perno guía con rodillo en latón .

Deviateur avec rouleau de guide .

ART.	Confez. Box	Peso Kg Weight
309D	25	0,240

FERMO DI ARRESTO CON PARACOLPO IN GOMMA

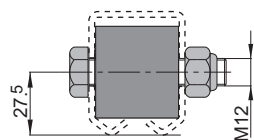

Back stop with rubber buffer.

Topo de detención con amortiguador de goma.

Ferme d'arrêt avec butoir en gomme.

ART.	Confez. Box	Peso Kg Weight
465	6	0,200

BLOCCHETTO GUIDA

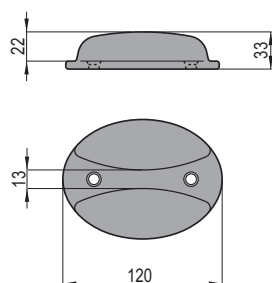

Meeting point.

Topo guía.

Bloc guide.

ART.	Confez. Box	Peso Kg Weight
BG/2000	12	1,370

ATTACCO LATERALE A FASCIA REGISTRABILE

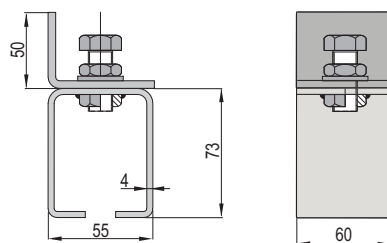
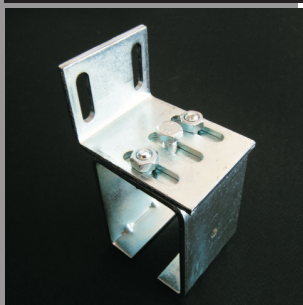

Adjustable lateral support.

Soporte lateral regulable.

Support pour latéral avec réglage.

ART.	Confez. Box	Peso Kg Weight
ALG10	10	0,600

ATTACCO A SOFFITTO A FASCIA REGISTRABILE

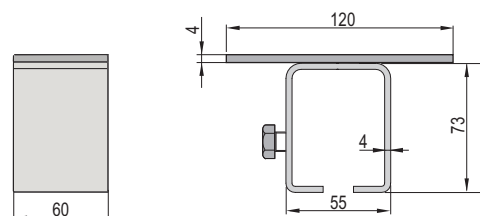

Adjustable support.

Soporte ou de techo, regulable para monorriel.

Support pour plafond avec réglage.

ART.	Confez. Box	Peso Kg Weight
ASG10	10	0,650

GUIDA INFERIORE IN ACCIAIO

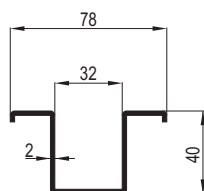

Lunghezza = 6 m
Length = 6 m
Longueur = 6 m
Longueur = 6 m

Lower guide in steel.

Guía inferior de acero.

Rail guide inferieur en acier.

ART.	Confez. Box	Peso Kg Weight
G8I	36 m n° 6x6 m	Kg/m 2,730



PETTITI GIUSEPPE s.p.a.

SERIE MINILUCE

PORTATA CAPACITY CAPACIDAD PORTEE	Per coppia di carrelli For each pair of trolleys Por par de carriles Pour couple de chariots
Kg 60	a 2 cuscinetti with 2 bearings de 2 cojinetes a 2 coussinets
Kg 85	a 4 cuscinetti with 4 bearings de 4 cojinetes a 4 coussinets

CARRELLI ED ACCESSORI PER MONOROTAIA G12A - G12Z

TROLLEYS AND ACCESSORIES FOR RAIL G12A - G12Z

CARRILES Y ACCESORIOS PARA MONORRIELES G12A - G12Z

CHARIOTS ET ACCESSOIRES POUR MONORAIL G12A - G12Z

MONOROTAIA IN ALLUMINIO GREZZO

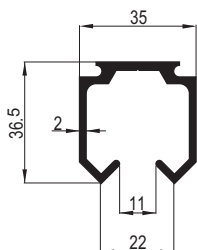
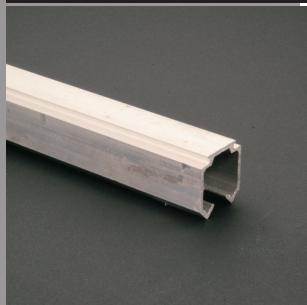

Lunghezza = 6 m
Length = 6 m
Largo = 6 m
Longueur = 6 m

Rail in aluminium

Monoriel de aluminio.

Monorail en aluminium.

ART.	Confez. Box	Peso Kg Weight
G12A	60 m n° 10x6 m	Kg/m 0,750

MONOROTAIA IN ACCIAIO ZINCATO, FORATA

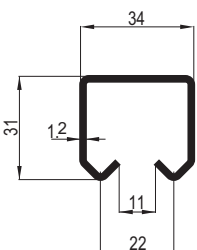
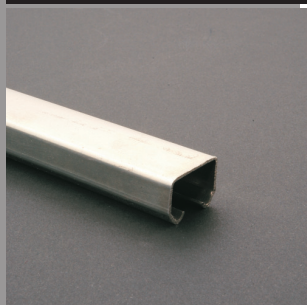

Lunghezza = 6 m
Length = 6 m
Largo = 6 m
Longueur = 6 m

Drilled rail in zinked steel.

Monoriel horada de acero galvanizado.

Monorail percé en acier zingue.

ART.	Confez. Box	Peso Kg Weight
G12Z	72 m n° 12x6 m	Kg/m 1,008

CARRELLO FISSO A 2 RUOTE

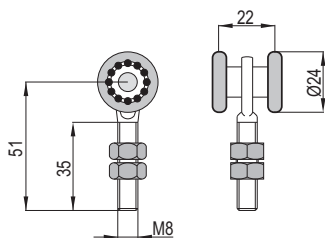

Fix trolley with 2 wheels.

Carro fijo con 2 ruedas .

Chariot fixe à 2 roul.

2RPP	Fisso - cuscinetti in acciaio Fix - steel bearings Fijo - cojinetes de acero Fixe - coussinets en acier
S2RPP	Fisso - cuscinetti in nylon Fix - nylon bearings Fijo - cojinetes de nylon Fixe - coussinets en nylon

ART.	Confez. Box	Peso Kg Weight
2RPP	60	0,070
S2RPP	60	0,060

CARRELLO FISSO A 4 RUOTE

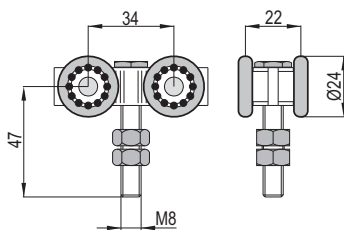

Fix trolley with 4 wheels.

Carro fijo con 4 ruedas .

Chariot fixe à 4 roul.

4RPP	Fisso - cuscinetti in acciaio Fix - steel bearings Fijo - cojinetes de acero Fixe - coussinets en acier
S4RPP	Fisso - cuscinetti in nylon Fix - nylon bearings Fijo - cojinetes de nylon Fixe - coussinets en nylon

ART.	Confez. Box	Peso Kg Weight
4RPP	30	0,125
S4RPP	30	0,095

CARRELLO GIREVOLE A 2 RUOTE

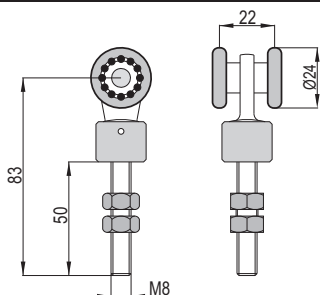

Rotating trolley with 2 wheels .

Carro giratorio con 2 ruedas .

Chariot pivotant à 2 roul.

2RPPS	Girevole- cuscinetti in acciaio Rotating - steel bearings Giratorio - cojinetes de acero Pivotant- coussinets en acier
S2RPPS	Girevole - cuscinetti in nylon Rotating - nylon bearings Giratorio - cojinetes de nylon Pivotant - coussinets en nylon

ART.	Confez. Box	Peso Kg Weight
2RPPS	60	0,115
S2RPPS	60	0,100



CARRELLO GIREVOLE IN ALLUMINIO A 4 RUOTE

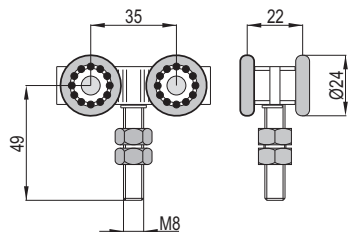

Rotating trolley in aluminium with 4 wheels.

Carro giratorio de aluminio con 4 ruedas.

Chariot pivotant en aluminium à 4 roulements.

4RPPS	Girevole - cuscinetti in acciaio Rotating - steel bearings Giratorio - cojinetes de acero Pivotant - coussinets en acier
S4RPPS	Girevole - cuscinetti in nylon Rotating - nylon bearings Giratorio - cojinetes de nylon Pivotant - coussinets en nylon

ART.	Confez. Box	Peso Kg Weight
4RPPS	30	0,125
S4RPPS	30	0,095

STAFFA DI FISSAGGIO ANTA IN ACCIAIO ZINCATO

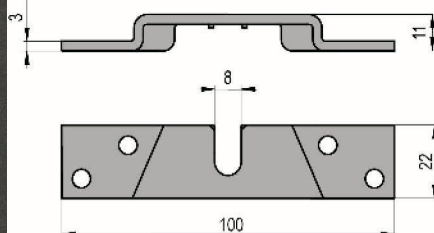

Fixing bracket in zinked steel.

Estribo para fijar de acero galvanizado.

Platine de fixation en acier zingué.

ART.	Confez. Box	Peso Kg Weight
STS303MSZ	30	0,048

CARRELLO FISSO A 2 RUOTE

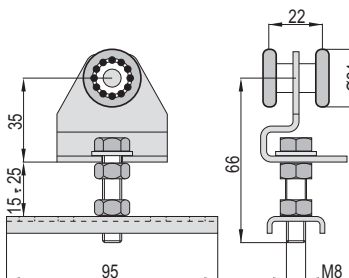

Fix trolley with 2 wheels.

Carril fijo con 2 ruedas .

Chariot fixe à 2 roulements .

2RM	Fisso - cuscinetti in acciaio Fix - steel bearings Fijo - cojinetes de acero Fixe - coussinets en acier
S2RM	Fisso - cuscinetti in nylon Fix - nylon bearings Fijo - cojinetes de nylon Fixe - coussinets en nylon

ART.	Confez. Box	Peso Kg Weight
2RM	60	0,170
S2RM	60	0,160

CARRELLO FISSO A 4 RUOTE

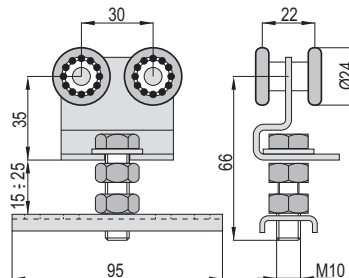
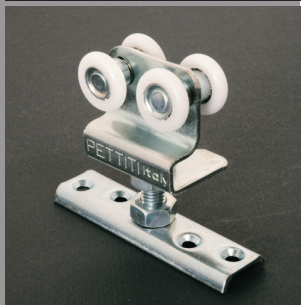

Fix trolley with 4 wheels.

Carril fijo con 4 ruedas .

Chariot fixe à 4 roulements .

4RM	Fisso - cuscinetti in acciaio Fix - steel bearings Fijo - cojinetes de acero Fixe - coussinets en acier
S4RM	Fisso - cuscinetti in nylon Fix - nylon bearings Fijo - cojinetes de nylon Fixe - coussinets en nylon

ART.	Confez. Box	Peso Kg Weight
4RM	30	0,250
S4RM	30	0,225

CARRELLO GIREVOLE A 2 RUOTE

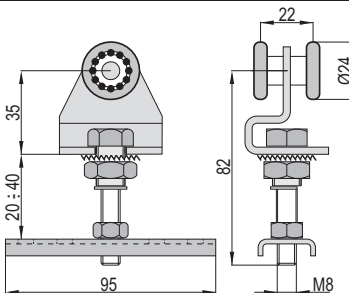

Rotating trolley with 2 wheels .

Carril giratorio con 2 ruedas .

Chariot pivotant à 2 roulements .

2RMG	Girevole - cuscinetti in acciaio Rotating - steel bearings Giratorio - cojinetes de acero Pivotant - coussinets en acier
S2RMG	Girevole - cuscinetti in nylon Rotating - nylon bearings Giratorio - cojinetes de nylon Pivotant - coussinets en nylon

ART.	Confez. Box	Peso Kg Weight
2RMG	30	0,195
S2RMG	30	0,180

CARRELLO GIREVOLE A 4 RUOTE

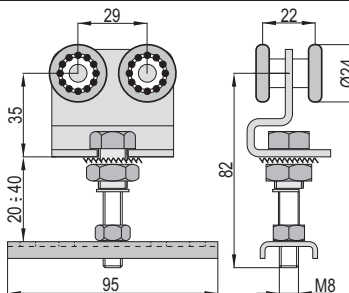

Rotating trolley with 4 wheels .

Carril giratorio con 4 ruedas .

Chariot pivotant à 4 roulements .

4RMG	Girevole - cuscinetti in acciaio Rotating - steel bearings Giratorio - cojinetes de acero Pivotant - coussinets en acier
S4RMG	Girevole - cuscinetti in nylon Rotating - nylon bearings Giratorio - cojinetes de nylon Pivotant - coussinets en nylon

ART.	Confez. Box	Peso Kg Weight
4RMG	30	0,260
S4RMG	30	0,235

CARRELLO A 2 RUOTE CON PIASTRA

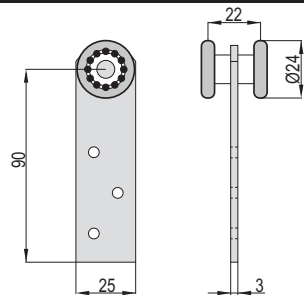

Trolley with 2 wheels, with plate.
Carril con 2 ruedas, con placa.
Chariot à 2 roulements, et plaque.

V1L2	Fisso - cuscinetti in acciaio Fix - steel bearings Fijo - cojinetes de acero Fixe - coussinets en acier
SV1L2	Fisso - cuscinetti in nylon Fix - nylon bearings Fijo - cojinetes de nylon Fixe - coussinets en nylon

ART.	Confez. Box	Peso Kg Weight
V1L2	30	0,095
SV1L2	30	0,080

CARRELLO FISSO A 2 RUOTE CON STAFFE MOBILI

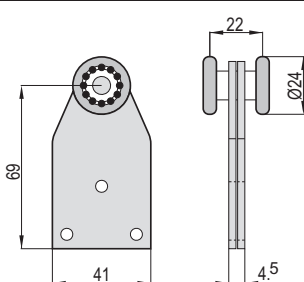

Fix trolley with 2 wheels, movable brackets.
Carro fijo con 2 ruedas, abrazaderas móviles.
Chariot fixe à 2 roulements, avec etriers mobiles.

V2	Fisso - cuscinetti in acciaio Fix - steel bearings Fijo - cojinetes de acero Fixe - coussinets en acier
-----------	--

ART.	Confez. Box	Peso Kg Weight
V2	50	0,120

CARRELLO FISSO A 2 RUOTE CON STAFFA FISSA

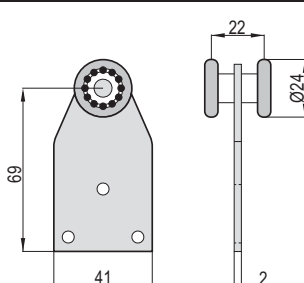

Fix trolley with 4 wheels, and fix plate.
Carro fijo con 4 ruedas, abrazadera desenganchable.
Chariot fixe à 4 roulements, avec etrier.

V2L	Fisso - cuscinetti in acciaio Fix - steel bearings Fijo - cojinetes de acero Fixe - coussinets en acier
------------	--

ART.	Confez. Box	Peso Kg Weight
V2L	50	0,080

CARRELLO FISSO A 4 RUOTE

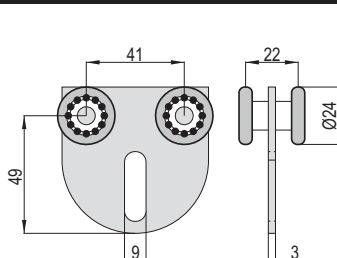

Fix trolley with 4 wheels.
Carro fijo con 4 ruedas.
Chariot fixe à 4 roulements.

4MLI	Fisso - cuscinetti in acciaio Fix - steel bearings Fijo - cojinetes de acero Fixe - coussinets en acier
S4MLI	Fisso - cuscinetti in nylon Fix - nylon bearings Fijo - cojinetes de nylon Fixe - coussinets en nylon

ART.	Confez. Box	Peso Kg Weight
4MLI	30	0,150
S4MLI	30	0,120

CARRELLO FISSO A 4 RUOTE PER TRASPORTO PIATTINA

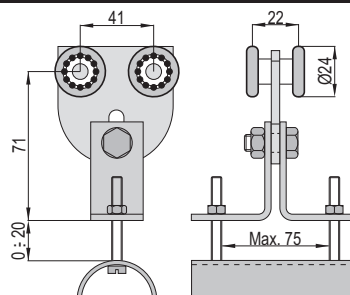

Fix trolley with 4 wheels, for strap transport.
Carril fijo para transporte de cable eléctrico con 4 ruedas.
Chariot fixe à 4 roulements pour transport de sangle.

4MLP	Fisso - cuscinetti in acciaio Fix - steel bearings Fijo - cojinetes de acero Fixe - coussinets en acier
-------------	--

ART.	Confez. Box	Peso Kg Weight
4MLP	10	0,355

FERMO DI ARRESTO CON PARACOLPI IN GOMMA

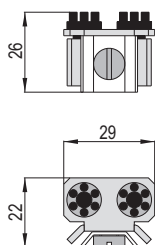

Back stop with rubber buffers.
Tope de detención con amortiguadores de goma.
Ferme d'arrêt avec butoir en gomme.

ART.	Confez. Box	Peso Kg Weight
412	100	0,020

PIASTRA FISSA CON OLIVA GIREVOLE CENTRALE

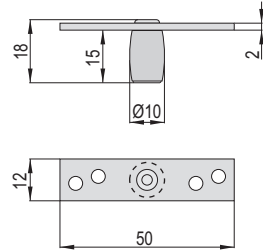
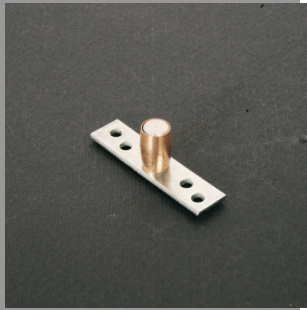

312B	Piastra in acciaio zincato, oliva in ottone. Plate in zinked steel, olive in brass. Plancha de acero galvanizado, oliva de latón. Platine en acier zingué, olive en laiton.
312BN/INOX	Piastra in acciaio inox, oliva in nylon. Plate in stainless steel, olive in nylon. Plancha de acero inox, oliva de nylon. Platine en acier inox, olive en nylon.

Fix plate with rotating olive.
Plancha fija con oliva.
Platine fixe avec olive articulée.

ART.	Confez. Box	Peso Kg Weight
312B	50	0,015
INOX - STAINLESS 312BN/INOX	50	0,015

PIASTRA FISSA CON OLIVA GIREVOLE LATERALE

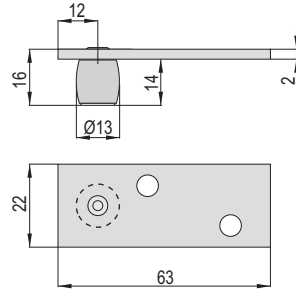
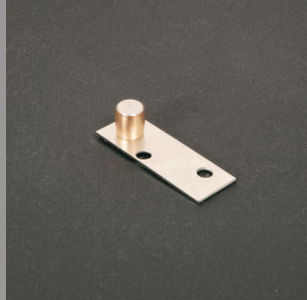

Fix plate with lateral rotating live in brass.
Plancha fija con oliva giratoria de latón.
Platine fixe avec olive pivotante en laiton.

ART.	Confez. Box	Peso Kg Weight
312A	80	0,045

GUIDA INFERIORE IN NYLON

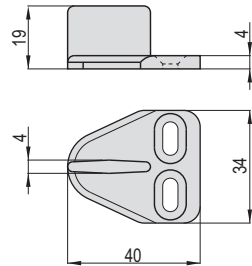

Lower guide in nylon.
Guía inferior con muela de nylon.
Guide inférieure en nylon.

ART.	Confez. Box	Peso Kg Weight
312	60	0,006

GUIDA INFERIORE IN NYLON

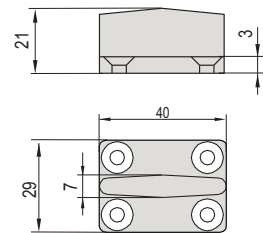

Lower guide in nylon.
Guía inferior con muela de nylon.
Guide inférieure en nylon.

ART.	Confez. Box	Peso Kg Weight
312/A	60	0,006

SUPPORTO LATERALE PER MONOROTAIA G12Z

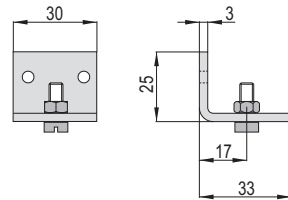
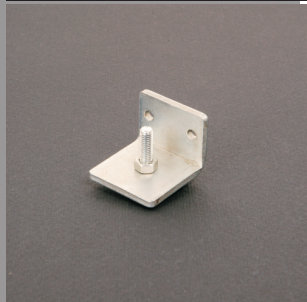

Side support for rail G12z.
Soporte lateral para monorriel G12Z.
Supporte lateral pour monorail G12Z.

ART.	Confez. Box	Peso Kg Weight
112PN	24	0,040

SUPPORTO LATERALE PER MONOROTAIA G12Z

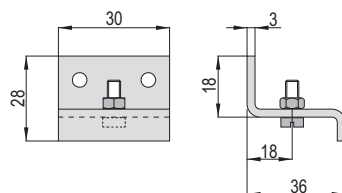

Side support for rail G12z.
Soporte lateral para monorriel G12Z.
Supporte lateral pour monorail G12Z.

ART.	Confez. Box	Peso Kg Weight
112PZ	24	0,036

SUPPORTO LATERALE PER MONOROTAIA G12A

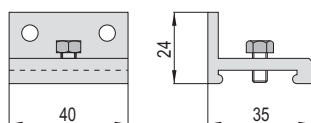

Side support for rail G12A.

Soporte lateral para monorriel G12A.

Support lateral pour rail G12A.

ART.	Confez. Box	Peso Kg Weight
LS 120V	30	0,030

ATTACCO LATERALE REGISTRABILE

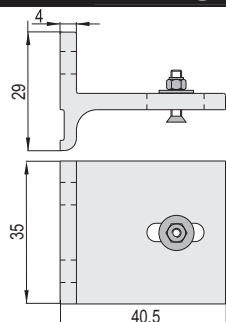
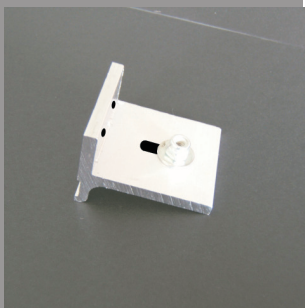

Lateral adjustable support.

Sujetador lateral regulable.

Support de fixation lateral réglable.

ART.	Confez. Box	Peso Kg Weight
LS 40-120	20	0,030

GUIDA INFERIORE IN ALLUMINIO GREZZO

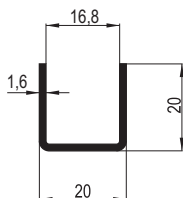
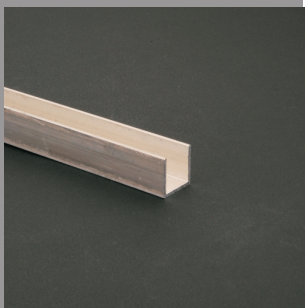

Lunghezza = 6 m
Length = 6 m
Largo = 6 m
Longueur = 6 m

Lower guide in aluminium.

Gúa inferior de aluminio.

Guide inférieure en aluminium.

ART.	Confez. Box	Peso Kg Weight
GIM	72 m n°12x6 m	Kg/m 0,235

SET SERIE MINILUCE

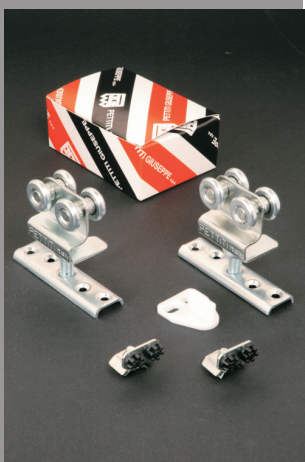

Set in contenitore di cartone composto da:
n. 2 carrelli completi (art. 4RM)
n. 2 fermi d'arresto (art. 412)
n. 1 guida inferiore (art. 312)

Set en boîte de carton composé par:
n. 2 chariots complets (art. 4RM)
n. 2 fermes d'arrêt (art. 412)
n. 1 guide inférieure (art. 312)

CONFEZIONI STANDARD PER MONOROTAIA G12A - G12Z

STANDARD PACKINGS FOR MONORAIL G12A - G12Z

CONFECCIONES STANDARD PARA MONORRIEL G12A - G12Z

CONDIT. STANDARD POUR RAIL G12A - G12Z

Set in carton box including:
n. 2 complete trolleys (art. 4RM)
n. 2 backstops (art. 412)
n. 1 lower guide (art. 312)

Set en caja de carton conteniente:
n. 2 carriles completos (art. 4RM)
n. 2 bloques de detencion (art. 412)
n. 1 guia inferior (art. 312)

ART.	Confez. Box	Peso Kg Weight
SET 4RM	24	0,575

SET SERIE MINILUCE



Set in contenitore di cartone composto da:
n. 2 carrelli completi (art. S4RM)
n. 2 fermi d'arresto (art. 412)
n. 1 guida inferiore (art. 312)

Set en boîte de carton composé par:
n. 2 chariots complets (art. S4RM)
n. 2 fermes d'arrêt (art. 412)
n. 1 guide inférieure (art. 312)

Set in carton box including:
n. 2 complete trolleys (art. S4RM)
n. 2 backstop (art. 412)
n. 1 lower guide (art. 312)

Set en caja de carton conteniente:
n. 2 carriles completos (art. S4RM)
n. 2 bloques de detencion (art. 412)
n. 1 guia inferior (art. 312)

ART.	Confez. Box	Peso Kg Weight
SET S4RM	24	0,520

**L'applicazione è valida per la serie Miniluce - The application is valid for Miniluce serie
 La aplicación es válida para la serie Miniluce - L'application est valide pour la série Miniluce**

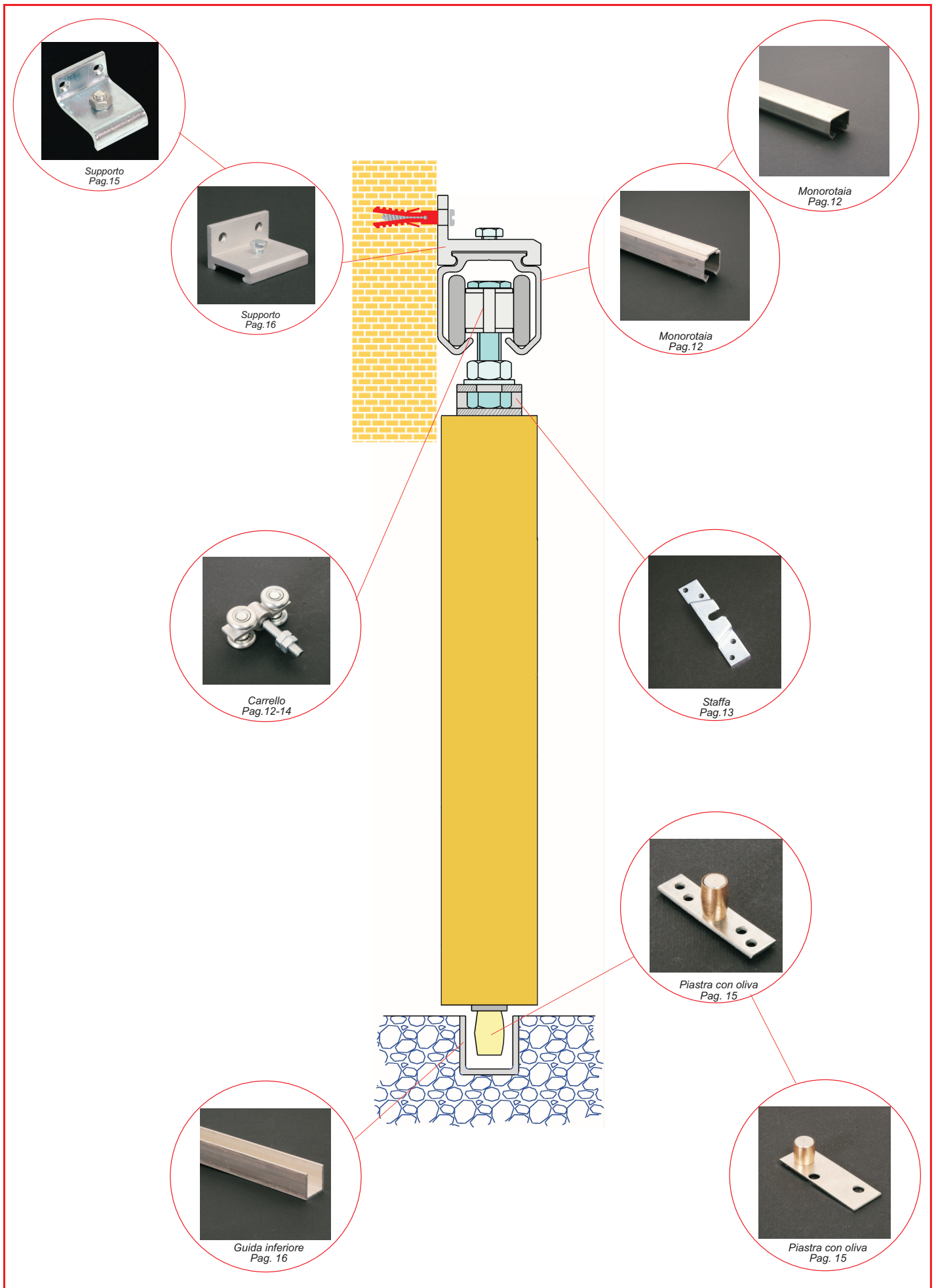



PETTITI GIUSEPPE s.p.a.

SERIE MINILUCE VERTICAL

PORTATA CAPACITY CAPACIDAD PORTEE	Per coppia di carrelli For each pair of trolleys Por par de carriles Pour couple de chariots
Kg 30	a 1 cuscinetto with 1 bearing con 1 cojinete a 1 coussinet

CARRELLI ED ACCESSORI PER MONOROTAIA G14Z

TROLLEYS AND ACCESSORIES FOR RAIL G14Z

CARRILES Y ACCESORIOS PARA MONORRIEL G14Z

CHARIOTS ET ACCESSOIRES POUR MONORAIL G14Z

MONOROTAIA IN ACCIAIO ZINCATO

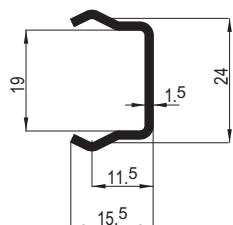
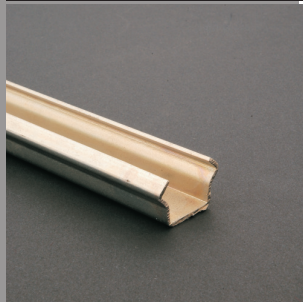

Lunghezza = 6 m
Length = 6 m
Largo = 6 m
Longueur = 6 m

Rail in zinked steel .

Monorriel de acero galvanizado .

Monorail en acier zingué.

ART.	Confez. Box	Peso Kg Weight
G14Z	72 m n° 12x6 m	Kg/m 0,650

MONOROTAIA DOPPIA IN ALLUMINIO GREZZO

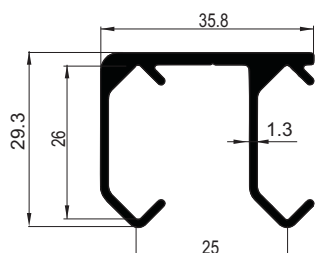

Lunghezza = 6 m
Length = 6 m
Largo = 6 m
Longueur = 6 m

Double rail in aluminium.

Doble monorriel de aluminio.

Double monorail en aluminium.

ART.	Confez. Box	Peso Kg Weight
G14AX2	72 m n° 12x6 m	Kg/m 0,527

CARRELLO FISSO A 1 RUOTA

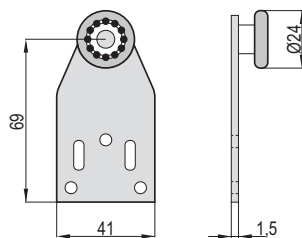

Fix trolley with 1 wheel.

Carro fijo con 1 rueda.

Chariot fixe à 1 roulement.

V1	Fisso - cuscinetti in acciaio Fix - steel bearings Fijo - cojinetes de acero Fixe - coussinets en acier
SV1	Fisso - cuscinetti in nylon Fix - nylon bearings Fijo - cojinetes de nylon Fixe - coussinets en nylon

ART.	Confez. Box	Peso Kg Weight
V1	50	0,060
SV1	50	0,055

CARRELLO FISSO A 1 RUOTA

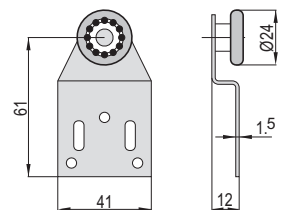

Fix trolley with 1 wheel.

Carro fijo con 1 rueda.

Chariot fixe à 1 roulement.

V1A	Fisso - cuscinetti in acciaio Fix - steel bearings Fijo - cojinetes de acero Fixe - coussinets en acier
SV1A	Fisso - cuscinetti in nylon Fix - nylon bearings Fijo - cojinetes de nylon Fixe - coussinets en nylon

ART.	Confez. Box	Peso Kg Weight
V1A	80	0,060
SV1A	80	0,055

CARRELLO FISSO A 1 RUOTA

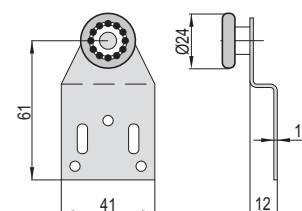

Fix trolley with 1 wheel.

Carro fijo con 1 rueda.

Chariot fixe à 1 roulement.

V1A/O	Fisso - cuscinetti in acciaio Fix - steel bearings Fijo - cojinetes de acero Fixe - coussinets en acier
SV1A/O	Fisso - cuscinetti in nylon Fix - nylon bearings Fijo - cojinetes de nylon Fixe - coussinets en nylon

ART.	Confez. Box	Peso Kg Weight
V1A/O	80	0,060
SV1A/O	80	0,055

CARRELLO FISSO A 1 RUOTA

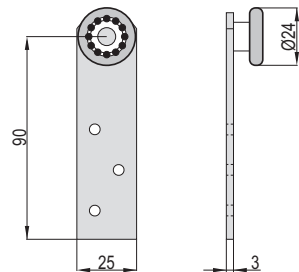

Fix trolley with 1 wheel.
Carro fijo con 1 rueda.
Chariot fixe à 1 roulement.

V1L	Fisso - cuscinetti in acciaio Fix - steel bearings Fijo - cojinetes de acero Fixe - coussinets en acier
SV1L	Fisso - cuscinetti in nylon Fixe - nylon bearings Fijo - cojinetes de nylon Fixe - coussinets en nylon

ART.	Confez. Box	Peso Kg Weight
V1L	50	0,070
SV1L	50	0,065

CARRELLO FISSO A 1 RUOTA

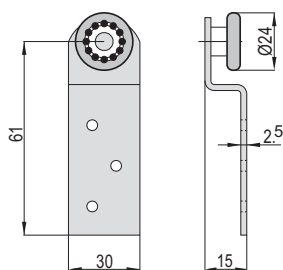
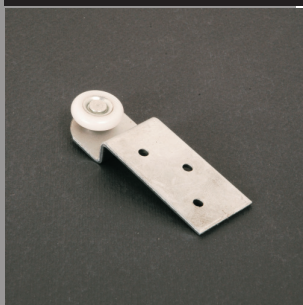

Fix trolley with 1 wheel.
Carro fijo con 1 rueda.
Chariot fixe à 1 roulement.

V1LA	Fisso - cuscinetti in acciaio Fix - steel bearings Fijo - cojinetes de acero Fixe - coussinets en acier
SV1LA	Fisso - cuscinetti in nylon Fix - nylon bearings Fijo - cojinetes de nylon Fixe - coussinets en nylon

ART.	Confez. Box	Peso Kg Weight
V1LA	50	0,070
SV1LA	50	0,065

CARRELLO FISSO A 1 RUOTA

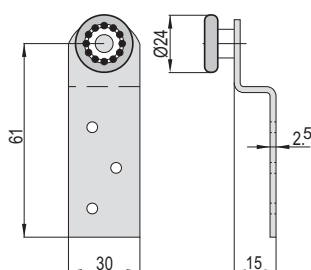

Fix trolley with 1 wheel.
Carro fijo con 1 rueda.
Chariot fixe à 1 roulement.

V1LA/O	Fisso - cuscinetti in acciaio Fix - steel bearings Fijo - cojinetes de acero Fixe - coussinets en acier
SV1LA/O	Fisso - cuscinetti in nylon Fix - nylon bearings Fijo - cojinetes de nylon Fixe - coussinets en nylon

ART.	Confez. Box	Peso Kg Weight
V1LA/O	50	0,070
SV1LA/O	50	0,065

CARRELLO FISSO A 1 RUOTA

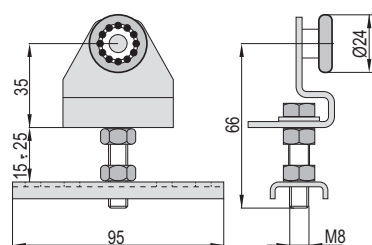

Fix trolley with 1 wheel.
Carril fijo con 1 rueda.
Chariot fixe à 1 roulement.

V1S	Fisso - cuscinetti in acciaio Fix - steel bearings Fijo - cojinetes de acero Fixe - coussinets en acier
SV1S	Fisso - cuscinetti in nylon Fix - nylon bearings Fijo - cojinetes de nylon Fixe - coussinets en nylon

ART.	Confez. Box	Peso Kg Weight
V1S	50	0,155
SV1S	50	0,150

CARRELLO FISSO A 2 RUOTE

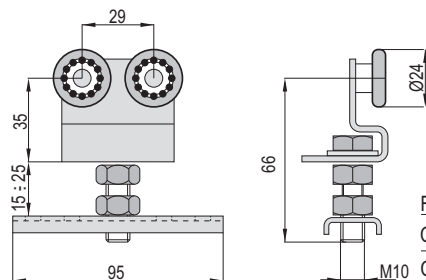

Fix trolley with 2 wheels.
Carril fijo con 2 ruedas.
Chariot fixe à 2 roulements.

V2S	Fisso - cuscinetti in acciaio Fix - steel bearings Fijo - cojinetes de acero Fixe - coussinets en acier
SV2S	Fisso - cuscinetti in nylon Fix - nylon bearings Fijo - cojinetes de nylon Fixe - coussinets en nylon

ART.	Confez. Box	Peso Kg Weight
V2S	50	0,230
SV2S	50	0,215

CARRELLO FISSO A 1 RUOTA

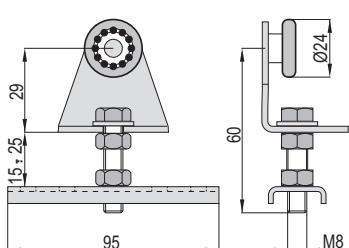

Fix trolley with 1 wheel.
Carril fijo con 1 rueda.
Chariot fixe à 1 roulement.

1RMS	Fisso - cuscinetti in acciaio Fix - steel bearings Fijo - cojinetes de acero Fixe - coussinets en acier
S1RMS	Fisso - cuscinetti in nylon Fix - nylon bearings Fijo - cojinetes de nylon Fixe - coussinets en nylon

ART.	Confez. Box	Peso Kg Weight
1RMS	30	0,140
S1RMS	30	0,130

FERMO DI ARRESTO CON PARACOLPO IN GOMMA

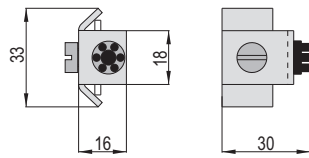

Back stop with rubber buffers.

Tope de detención con amortiguadores de goma

Ferme d'arrêt avec butoir en gomme.

ART.	Confez. Box	Peso Kg Weight
414	100	0,020

GUIDA INFERIORE IN PLASTICA

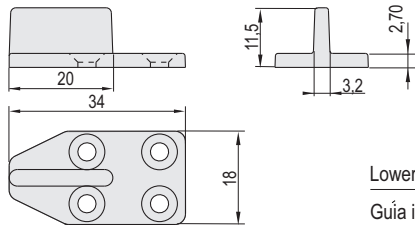
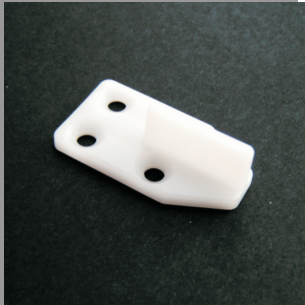

Lower guide in plastic.

Guía inferior de plástico.

Guide inférieur en plastique.

ART.	Confez. Box	Peso Kg Weight
316	50	0,002

GUIDA INFERIORE IN NYLON

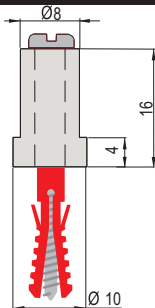

Lower guide in nylon.

Guía inferior de nylon.

Guide inférieure en nylon.

ART.	Confez. Box	Peso Kg Weight
312R	60	0,003

Applicazione con monorotaia doppia.

Applicazione con monorotaia doppia.

Applicazione con monorotaia doppia.

Applicazione con monorotaia doppia.

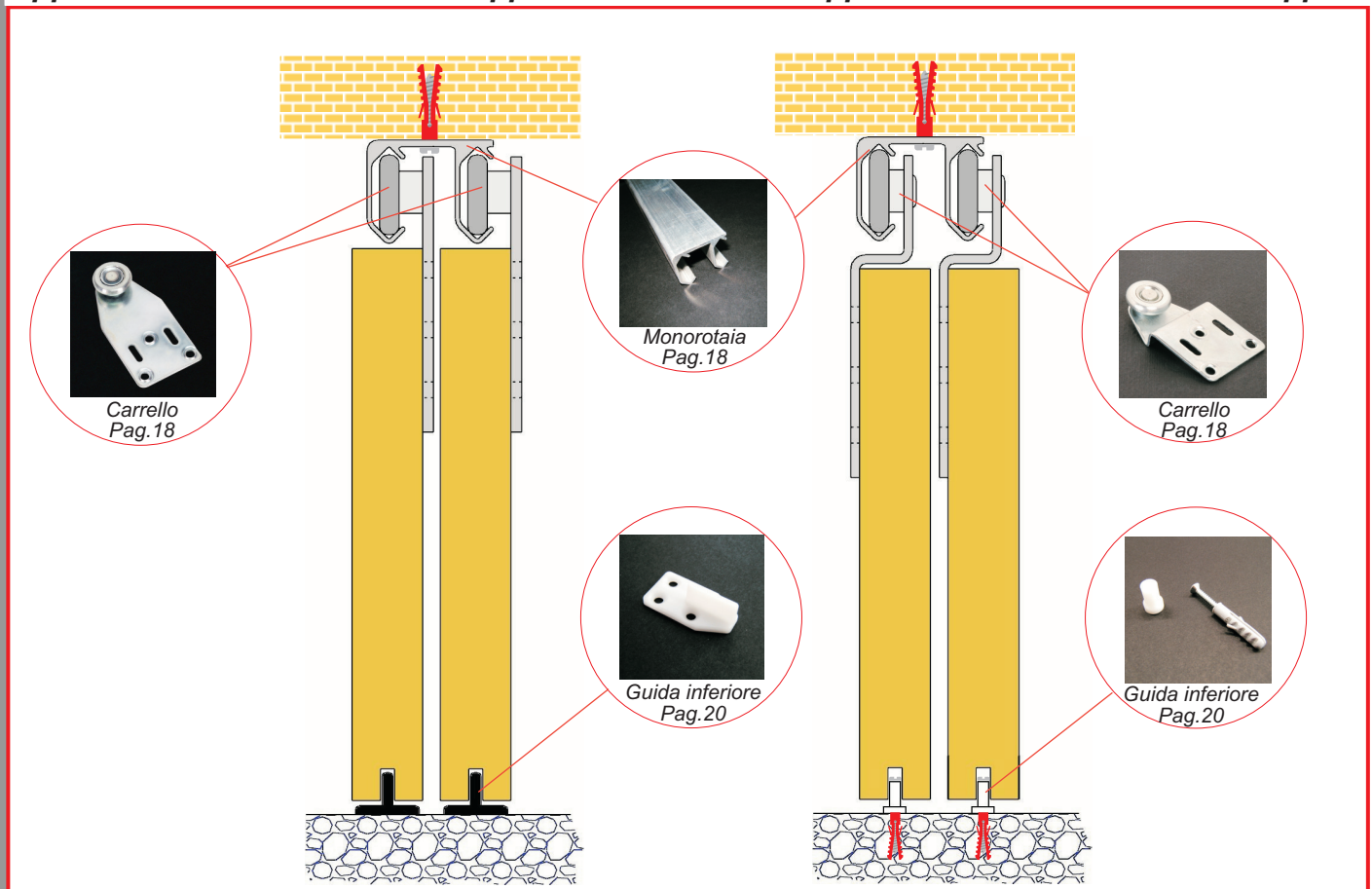



PETTTI GIUSEPPE s.p.a.

INDICE ARTICOLI

ART.	PAG.	ART.	PAG.	ART.	PAG.	ART.	PAG.
111D/CS	55	4SA 40	36	C/7	66	GCA275M	69
111D/NL	55	4SA 60	36	C68	60	GCA300B	69
111D/NS	55	4SL 40	35	CA/M300	3	GCA300M	69
111D/OL	55	4SL 60	35	CA/M600	1	GCA350B	69
111S/CS	55	5631 A	59	CL110X25	53	GCA350M	69
111S/NL	55	5631 B	59	CL110X25/OT	53	GCA400B	69
111S/NS	55	5631 W	59	CL45X12/INOX	53	GCA400M	69
111S/OL	55	5633 A	59	CL61X13/INOX	53	GCA450B	69
203/BR	20	5633 B	59	CL62X16	53	GCA450M	69
203/CL	20	5633 W	59	CL62X16/CS	53	GCA500B	69
203/CS	20	95D/CS	55	CL62X16/OT	53	GCA500M	69
203/NS	20	95D/NL	55	CL95X19	53	GCA550B	69
203/OL	20	95D/NS	55	CL95X19/CS	53	GCA550M	69
204/BR	20	95D/OL	55	CL95X19/INOX	53	GCA600B	69
204/CL	20	95S/CS	55	CL95X19/OT	53	GCA600M	69
204/CS	20	95S/NL	55	CLA/13	58	GI600	2
204/NS	20	95S/NS	55	CLA/14	58	GI600	4
204/OL	20	95S/OL	55	CLA/16	58	GIM	6, 13, 35, 36
210S	1	A/1	67	CLC160X20/CL	54	GNL	16
2SA 20	36	A/2	67	CLC160X20/VN	54	K202/BR	20
2SA 30	36	A/3	67	CLC160X20/ZG	54	K202/CL	20
2SL 20	35	A/4	67	CLP90X25/CL	54	K202/CS	20
2SL 30	35	A/5	67	CLP90X25/CS	54	K202/NS	20
300S	3	A/6	67	CLP90X25/OL	54	K202/OL	20
309/25	1, 3	A/7	67	CLS/13	58	KCM/MS80	33
309/30	1, 3	A/8	67	CLS/14	58	KE 40/B	30
310	5	AC/3	68	CLS/16	58	KE 40/C	30
310N/INOX	5	AC/4	68	CM/MS80	33	KE 40/D	30
312	11	AF4	13	CTL/200	60	KE 80/B	30
312/4	11	AG/1	67	CTL/300	60	KE 80/C	30
312/A	11	AG/3	67	CTL/400	60	KE 80/D	30
312B	11, 21	AG/4	67	DFPSS	63	KM 80	16
312BN/INOX	11, 21	AG/5	68	DSSPB	62	KM/A	18
312P/35/INOX	23	AG/6	68	FP14	61	KM/B	18
312P/42/INOX	23	AG/7	13	FP24	61	KM/G	18
312R	12	ANL/A	16	FP60	61	KPP/I	38
312S	11	ANL/A	18	FP60/Z	61	KPPB/C	44
312V	49	ANL/B	16	FPD	62	KPPC/I	39
312V/AL	49	ANL/B	18	FPP	59	KPPL/I	40
316	11	ANL/G	16	FPP/INOX	59	KPPLB	42
420	5	ANL/G	18	FPPS	59	KS 120/B	30
420/INOX	5	AS80	9	FPS	62	KS 120/C	30
420R	6	ASP/16	63	FPSS	62	KS 120/D	30
420R/INOX	6	ASP/26	63	FPT/25CL	59	KS 120/E	30
430	4	ASP/32	63	FPT/25INOX	59	KS 20/B	30
460	2	BPD	63	FPT/25L	59	KS 20/C	30
4S200	5	C/1	66	G/MM80E65	21	KS 20/D	30
4S200/INOX	5	C/11	66	GCA250B	69	KS 20/E	30
4S300	3	C/2	66	GCA250M	69	KS 40/B	30
4S600	1	C/4	66	GCA275B	69	KS 40/C	30



ART.	PAG.
KS 40/D	30
KS 40/E	30
KS 60/B	30
KS 60/C	30
KS 60/D	30
KS 60/E	30
KS 80/B	30
KS 80/C	30
KS 80/D	30
KS 80/E	30
KT 80	18
LS 120	9
LS 120V	10
LS 20	9
LS 300	4
LS 300	5
LS 40	9
LS 40-120	10
LS 4060X2	10
LS 40V	10
LS 60	9
LS 600	2
LS 60V	10
LS 80	9
LS 80V	10
LS 80V35	10
ML/A	16
ML/A	18
ML/B	16
ML/B	18
ML/G	16
ML/G	18
ML80/E	21
MM 80P2	12
MM 80P4	12
MM 80PV2	47
MM 80PV4	47
MM 80S2	12
MM 80S4	12
MM80E	21
MPV40	48
MPV400	48
MS 120	9
MS 120/NA	9
MS 20	8
MS 20/NA	8
MS 200	5
MS 200/NA	5
MS 20X2	9
MS 300/NA	3
MS 40	8
MS 40/NA	8
MS 40X2	9
MS 60	8
MS 60/NA	8

ART.	PAG.
MS 600/NA	1
MS 80	8
MS 80/NA	8
MS/KPP	38, 39, 40
MS/KPP/3	38, 39, 40
MS120/2	9
MS120/4	9
MS120/NA2	9
MS120/NA4	9
MS20/2	8
MS20/4	8
MS20/NA2	8
MS20/NA4	8
MS40/2	8
MS40/4	8
MS40/NA2	8
MS40/NA4	8
MS60/2	8
MS60/4	8
MS60/NA2	8
MS60/NA4	8
MS80/2	8
MS80/4	8
MS80/E	21
MS80/NA2	8
MS80/NA4	8
MX 120/2	50, 52
MX 120/4	50, 52
PAB	60
PAO	60
PGA	63
PIAS/111	56
PIAS/95	56
PPB	60
PPO	60
RSL100	48
RSV100	48
S 120	25
S 120/INOX	25
S 20	25
S 200	6
S 200/INOX	6
S 300	4
S 40	25
S 60	25
S 600	2
S 80	25
S 80I/INOX	25
S M40L	16
S M80	12, 47
S M80L	16
S M80S	13
SCAC	29
SF 120	27
SF 20	27

ART.	PAG.
SF 40	27
SF 60	27
SF 80	27
SMM01	13
SMM02	13
SMM03	13
SPP/I	38
SPP110	61
SPPC/I	39
SPPL/I	40
SSPB	62
SSPS	65
STAFF/PX25	50
STAFF/VX 25	50
STAFF40X45N	14
STAS	14
STAS/40	14
STOP/AMT	31
STOP/LS80	31
SV100	48
SVA 120	52
SVF 80	45
SVP 80	45
SVX 120	50
T M80	12, 47
TAP/95	57
TC/MM80E	21



PETTITI GIUSEPPE s.p.a.

SERIE MONOSILENT

PORTATA CAPACITY CAPACIDAD PORTEE	Per coppia di carrelli For each pair of trolleys Por par de carriles Pour couple de chariots a 4 cuscinetti with 4 bearings con 4 cojinetes à 4 coussinets
Kg 600	

CARRELLI ED ACCESSORI PER MONOROTAIA MS600/NA

TROLLEYS AND ACCESSORIES FOR RAIL MS600/NA

CARRILES Y ACCESORIOS PARA MONORRIEL MS600/NA

CHARIOTS ET ACCESSOIRES POUR MONORAIL MS600/NA

MONOROTAIA IN ALLUMINIO GREZZO

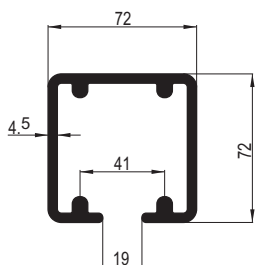
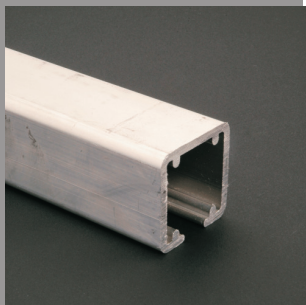

MS 600/NA Monorotaia in alluminio grezzo

Lunghezza = 6 m
Length = 6 m
Largo = 6 m
Longueur = 6 m

Rail in aluminium.
Monoriel de aluminio.
Monorail en aluminium.

ART.	Confez. Box	Peso Kg Weight
MS 600/NA	24 m n° 4x6 m	Kg/m 3,510

CARRELLO FISSO CENTRALE A 4 RUOTE IN NYLON

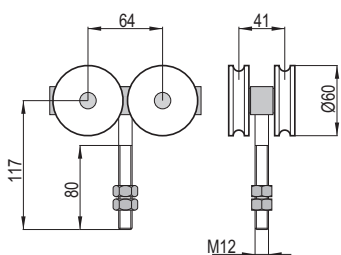

Central fix trolley with 4 wheels in nylon.
Carril fijo centrado, con 4 ruedas de nilón.
Chariot fixe à 4 roulements, en nylon.

ART.	Confez. Box	Peso Kg Weight
4S600	6	1,100

CARRELLO FISSO CENTRALE A 4 RUOTE IN NYLON

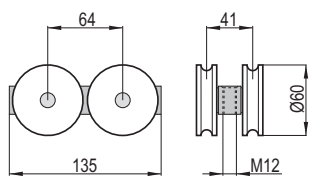

Central fix trolley with 4 wheels in nylon.
Carril fijo centrado, con 4 ruedas de nilón.
Chariot fixe à 4 roulements, en nylon.

Perno centrale eseguibile su richiesta .
Central pin feasible on request.
Perno centrado a pedido.
Pivot central exécutable sur demande .

ART.	Confez. Box	Peso Kg Weight
CA/M600	6	0,950

PIASTRA GIREVOLE IN ACCIAIO SU SFERE

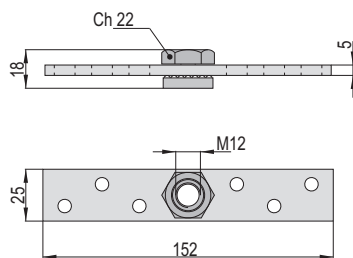
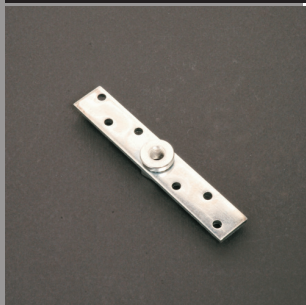

Rotating plate in zinked steel on balls.
Plancha giratoria de acero galvanizado sobre bolas.
Platine articulée en acier zingué sur billes.

ART.	Confez. Box	Peso Kg Weight
210S	50	0,170

PIASTRA FISSA CON OLIVA GIREVOLE IN OTTONE

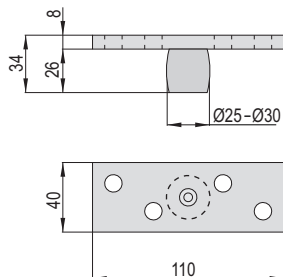
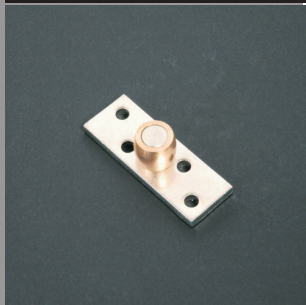

Fix plate with rotating olive in brass.
Plancha fija con oliva giratoria de latón.
Platine fixe avec olive articulée en laiton.

ART.	Confez. Box	Peso Kg Weight
309/25	25	0,340
309/30	25	0,380

FERMO IN ALLUMINIO CON PARACOLPO

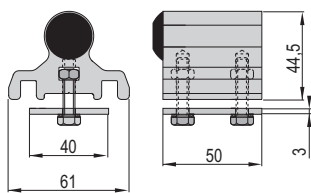
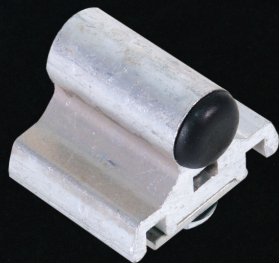

Back stop in aluminium with rubber buffer.

Topo de detencion con amortiguador de goma.

Ferme d'arrêt en aluminium avec butoir en gomme.

ART.	Confez. Box	Peso Kg Weight
460	6	0,290

SUPPORTO A PARETE IN ALLUMINIO GREZZO

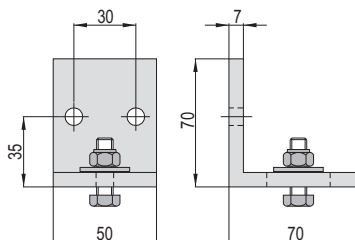

Wall support in rough aluminium.

Soporte de pared de aluminio bruto.

Support a pard en aluminium brut.

ART.	Confez. Box	Peso Kg Weight
LS 600	10	0,140

GUIDA INFERIORE IN ALLUMINIO GREZZO

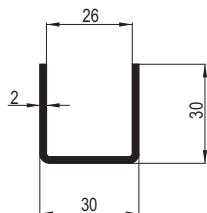
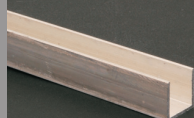

Lunghezza = 6 m

Length = 6 m

Longueur = 6 m

Largo = 6m

Lower guide in rough aluminium.

Guía inferior de aluminio bruto.

Guide inferieure en aluminium brut.

ART.	Confez. Box	Peso Kg Weight
GI600	36 m n° 6x6 m	Kg/m 0,464

SET

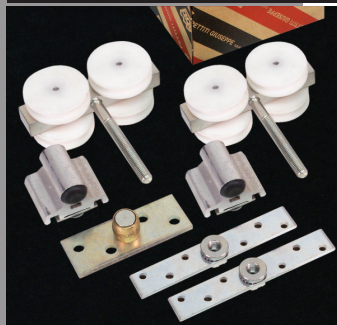

Set in contenitore di cartone per monorotaia MS600/NA composto da:
n. 2 carrelli (art. 4S600)
n. 2 piastre girevoli (art. 210S)
n. 2 fermi d'arresto (art. 460)
n. 1 piastra fissa (art. 309/25)

Set in carton box for rail MS600/NA including:
n. 2 trolleys (art. 4S600)
n. 2 rotating plates (art. 210S)
n. 2 backstop (art. 460)
n. 1 fixed plate (art. 309/25)

Set en caja de cartón para monorriel MS600/NA compuesto por:
n. 2 carriles (art. 4S600)
n. 2 planchas giratorias (art. 210S)
n. 2 bloques de detencion (art. 460)
n. 1 plancha fija (art. 309/25)

Set en boîte de carton pour monorail MS600 composé par:
n. 2 chariots (art. 4S600)
n. 2 platines articulées (art. 210S)
n. 2 fermes d'arret (art. 460)
n. 1 platine fixe (art. 309/25)

ART.	Confez. Box	Peso Kg Weight
S 600	1	3,460

S 200 - S 300 - S 600 - Fissaggio a parete

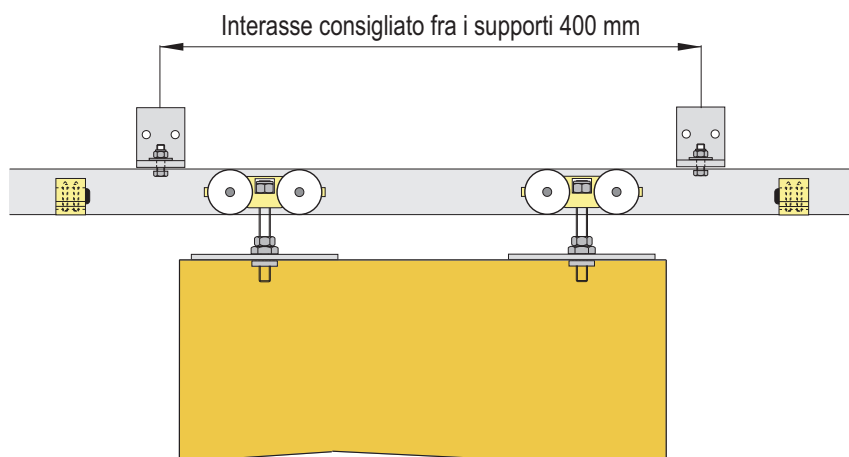



PETTITI GIUSEPPE s.p.a.

SERIE MONOSILENT

PORTATA CAPACITY CAPACIDAD PORTEE	Per coppia di carrelli For each pair of trolleys Por par de carriles Pour couple de chariots a 4 cuscinetti with 4 bearings con 4 cojinetes à 4 coussinets
Kg 300	

CARRELLI ED ACCESSORI PER MONOROTAIA MS300/NA

TROLLEYS AND ACCESSORIES FOR RAIL MS300/NA

CARRILES Y ACCESORIOS PARA MONORRIEL MS300/NA

CHARIOTS ET ACCESSOIRES POUR MONORAIL MS300/NA

MONOROTAIA IN ALLUMINIO GREZZO

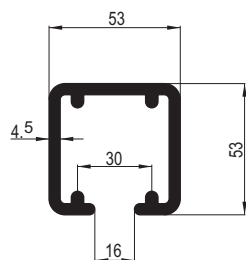
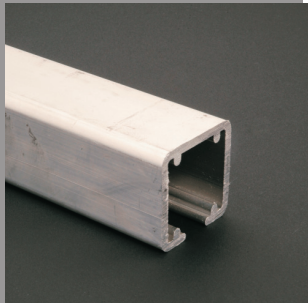

MS 300/NA Monorotaia in alluminio grezzo

Lunghezza = 6 m
Length = 6 m
Largo = 6 m
Longueur = 6 m

Rail in aluminium.
Monorriel de aluminio.
Monorail en aluminium.

ART.	Confez. Box	Peso Kg Weight
MS 300/NA	36 m n° 6x6 m	Kg/m 2,310

CARRELLO FISSO CENTRALE A 4 RUOTE IN NYLON

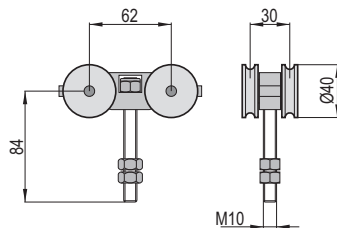

Central fix trolley with 4 wheels in nylon.
Carril fijo centrado, con 4 ruedas de nilón.
Chariot fixe à 4 roulements, en nylon.

In alluminio.
In aluminium.
De aluminio.
En aluminium.

ART.	Confez. Box	Peso Kg Weight
4S300	12	0,270

CARRELLO FISSO CENTRALE A 4 RUOTE IN NYLON

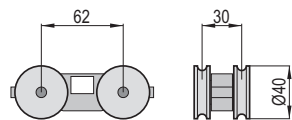
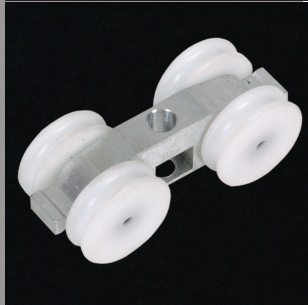

Central fix trolley with 4 wheels in nylon.
Carril fijo centrado, con 4 ruedas de nilón.
Chariot fixe à 4 roulements, en nylon.

In alluminio.
In aluminium.
De aluminio.
En aluminium.

ART.	Confez. Box	Peso Kg Weight
CA/M300	12	0,240

PIASTRA GIREVOLE IN ACCIAIO SU SFERE

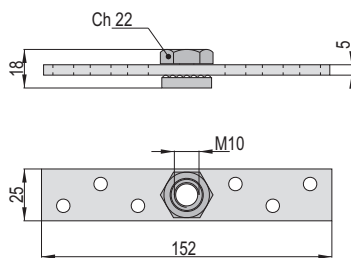

Rotating plate in zinked steel on balls.
Plancha giratoria de acero galvanizado sobre bolas.
Platine articulée en acier zingue sur billes.

ART.	Confez. Box	Peso Kg Weight
300S	30	0,170

PIASTRA FISSA CON OLIVA GIREVOLE IN OTTONE

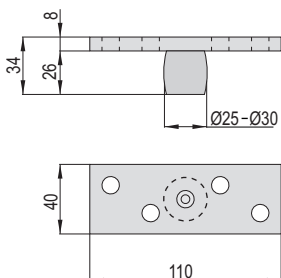
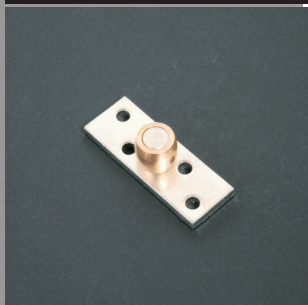

Fix plate with rotating olive in brass.
Plancha fija con oliva giratoria de laton.
Platine fixe avec olive articulée en laiton.

ART.	Confez. Box	Peso Kg Weight
309/25	25	0,340
309/30	25	0,380

FERMO IN ALLUMINIO CON PARACOLPO

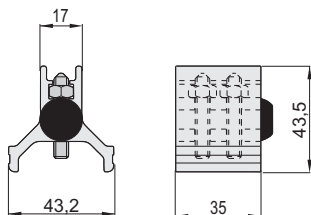
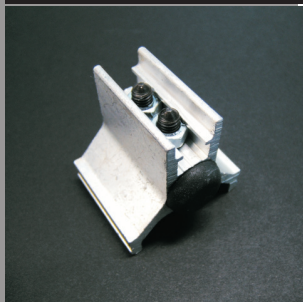

Back stop in aluminium with rubber buffer.

Tope de detencion con amortiguador de goma.

Ferme d'arrêt en aluminium avec butoir en gomme.

ART.	Confez. Box	Peso Kg Weight
430	12	0,065

SUPPORTO A PARETE IN ALLUMINIO GREZZO

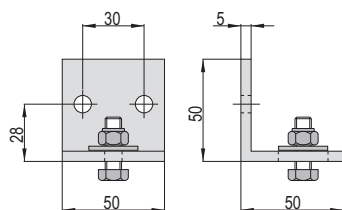
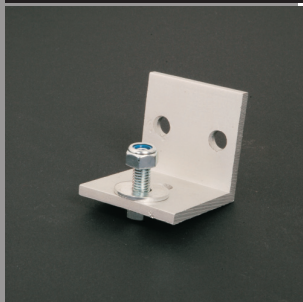

Wall support in rough aluminium.

Soporte de pared de aluminio bruto.

Support à pard en aluminium brut.

ART.	Confez. Box	Peso Kg Weight
LS 300	12	0,085

GUIDA INFERIORE IN ALLUMINIO GREZZO

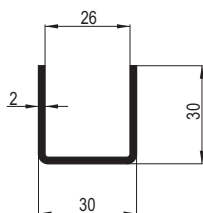
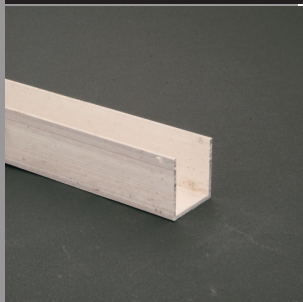

Lunghezza = 6 m
Length = 6 m
Longueur = 6 m
Largo = 6m

Lower guide in rough aluminium.

Guía inferior de aluminio bruto.

Guide inferieure en aluminium brut.

ART.	Confez. Box	Peso Kg Weight
GI600	36 m n° 6x6 m	Kg/m 0,464

SET



Set in contenitore di cartone per monorotaia MS300/NA composto da:
n. 2 carrelli (art. 4S300)
n. 2 piastre girevoli (art. 300S)
n. 2 fermi d'arresto (art. 430)
n. 1 piastra fissa (art. 309/25)

Set in carton box for rail MS300/NA including:
n. 2 trolleys (art. 4S300)
n. 2 rotating plates (art. 300S)
n. 2 backstop (art. 430)
n. 1 fixed plate (art. 309/25)

Set en caja de carton para monoriel MS300/NA compuesto por:
n. 2 carriles (art. 4S300)
n. 2 planchas giratorias (art. 300S)
n. 2 bloques de detencion (art. 430)
n. 1 plancha fija (art. 309/25)

Set en boîte de carton pour monorail MS300 composé par:
n. 2 chariots (art. 4S300)
n. 2 platines articulées (art. 300S)
n. 2 fermes d'arrêt (art. 430)
n. 1 platine fixe (art. 309/25)

ART.	Confez. Box	Peso Kg Weight
S 300	6	1,385

S 200 - S 300 - S 600 Fissaggio a soffitto

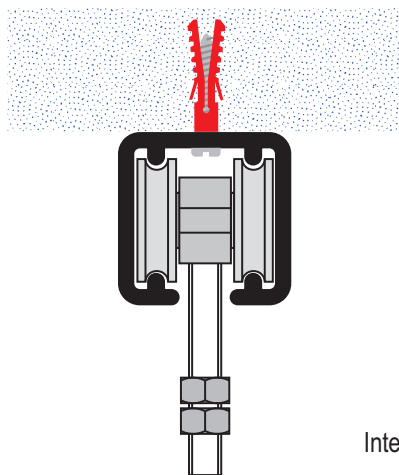

Interasse foratura consigliato 200 mm



PETTITI GIUSEPPE s.p.a.

SERIE MONOSILENT

PORTATA CAPACITY CAPACIDAD PORTEE	Per coppia di carrelli For each pair of trolleys Por par de carriles Pour couple de chariots
Kg 200	a 4 cuscinetti with 4 bearings con 4 cojinetes à 4 coussinets

CARRELLI ED ACCESSORI PER MONOROTAIA MS 200

TROLLEYS AND ACCESSORIES FOR RAIL MS 200

CARRILES Y ACCESSORIOS PARA MONORRIEL MS 200

ACCESSOIRES POUR MONORAIL MS 200

MONOROTAIA IN ALLUMINIO GREZZO E ANODIZZATO

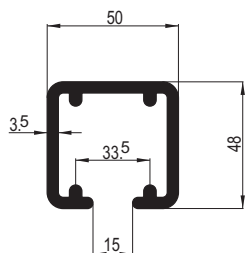
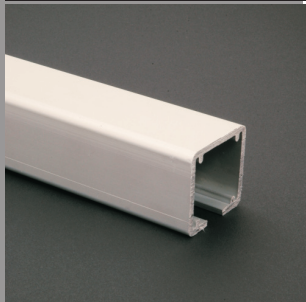

MS 200	Monorotaia in alluminio anodizzato
MS 200/NA	Monorotaia in alluminio grezzo

Lunghezza = 6 m
Length = 6 m
Largo = 6 m
Longueur = 6 m

Rail in anodized and rough aluminium ,trolleys ϕ 36.

Monorriel de aluminio para carriles ϕ 36.

Monorail en aluminium brut pour chariots ϕ 36.

ART.	Confez. Box	Peso Kg Weight
MS 200	54 m n° 9x6 m	Kg/m 1,680
MS 200/NA	54 m n° 9x6 m	Kg/m 1,680

CARRELLO FISSO IN ALLUMINIO A 4 RUOTE

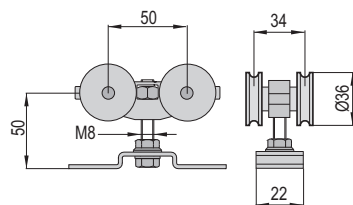
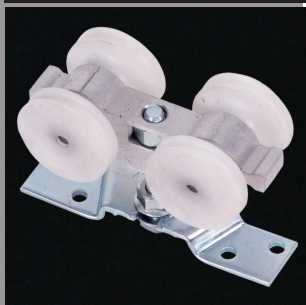

Fix trolley in aluminium ,with 4 wheels .

Carril fijo de aluminio con 4 ruedas .

Chariot fixe en aluminium à 4 roulements.

4S200/INOX:staffa e viti in acciaio inox.
Consigliato per applicazioni esterne.
4S200/INOX: bracket and screws in inox.
Recommended for outside use.
4S200/INOX: platine et vis en inox.
Recommandé pour applications a l'extérieures.

ART.	Confez. Box	Peso Kg Weight
4S200	12	0,251
INOX - STAINLESS 4S200/INOX	12	0,251

SUPPORTO A PARETE IN ALLUMINIO GREZZO

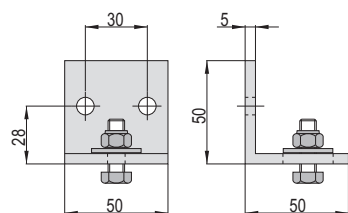
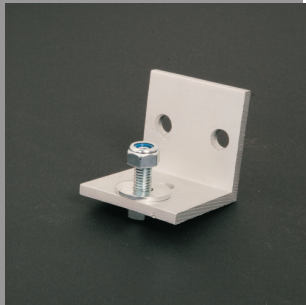

Wall support in rough aluminium .

Soporte de pared de aluminio bruto .

Support a pard en aluminim brut .

ART.	Confez. Box	Peso Kg Weight
LS 300	12	0,085

PIASTRA FISSA CON OLIVA GIREVOLE

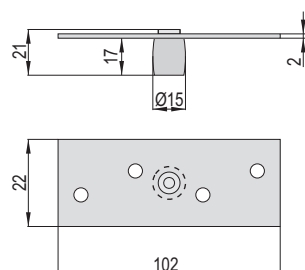
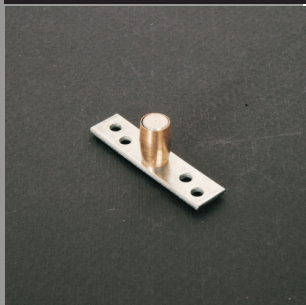

Fix plate with rotating olive.

Plancha fija con oliva giratoria.

Platine fixe avec olive articulée.

310	Piastra in acciaio zincato, oliva in ottone. Plate in zinked steel, olive in brass. Plancha de acero galvanizado, oliva de laton. Platine en acier zingué, olive en laiton.
310N/INOX	Piastra in acciaio inox, oliva in nylon. Plate in stainless steel, olive in nylon. Plancha de acero inox, oliva de nylon. Platine en acier inox, olive en nylon.

ART.	Confez. Box	Peso Kg Weight
310	50	0,055
INOX - STAINLESS 310N/INOX	50	0,055

FERMO DI FINE CORSA IN ALLUMINIO CON PARACOLPO

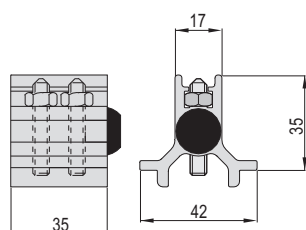

Back stop in aluminium with rubber buffer.

Tope de detencion de aluminio con amortiguador de goma .

Ferme d'arrêt en aluminium avec butoir en gomme .

420/INOX: viti in acciaio inox.
Consigliato per applicazioni esterne.
420/INOX: screws en inox.
Recommended for outside use.
420/INOX: vis en inox.
Recommandé pour applications a l'extérieures.

ART.	Confez. Box	Peso Kg Weight
420	12	0,059
INOX - STAINLESS 420/INOX	12	0,059

FERMO DI FINE CORSA IN ALLUMINIO CON RITENUTA, REGOLABILE

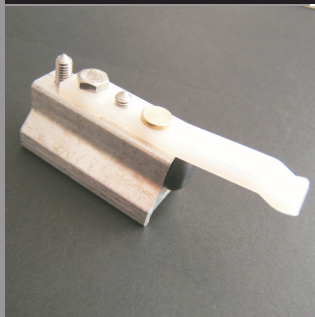

**NOVITÀ - NEW
NUEVO - NOUVEAU**

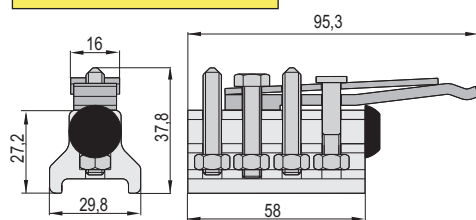

Back stop in aluminium with restraint, adjustable
Tope de detencion de aluminio con retencion ajustable,
Ferme d'arret en aluminium avec retenue, réglable

420R/INOX: viti in acciaio inox. Consigliato per applicazioni esterne.
420R/INOX: screws en inox. Recommended for outside use.
420R/INOX: vis en inox. Recommandé pour applications a l'extérieures.

ART.	Confez. Box	Peso Kg Weight
420R	12	0,107
INOX - STAINLESS 420R/INOX	12	0,107

GUIDA INFERIORE IN ALLUMINIO GREZZO

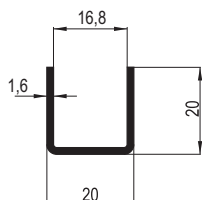
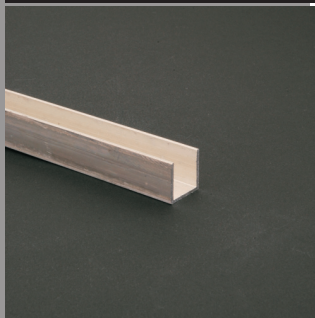

Lunghezza = 6 m
Length = 6 m
Largo = 6 m
Longueur = 6 m

Lower guide in rough aluminium.

Guía inferior de aluminio bruto.

Guide inferieure en aluminium brut.

ART.	Confez. Box	Peso Kg Weight
GIM	72 m n° 12x6 m	Kg/m 0,235

SET

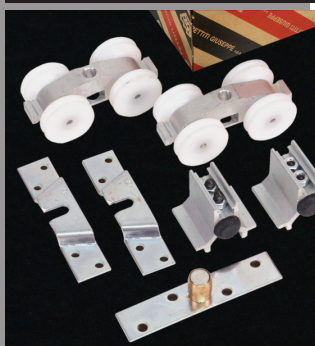

Set in contenitore di cartone per monorotaia MS200/NA - MS200 composto da:
n. 2 carrelli completi
n. 2 fermi d'arresto
n. 1 guida inferiore (art. 310)
viti di fissaggio

Set in carton box for rail MS200/NA - MS200 including:
n. 2 complete trolleys
n. 2 backstop
n. 1 lower guide (art. 310)
fixing screws

Set en boite de carton pour monorail MS300/NA composé de:
n. 2 chariots (art. 4S300)
n. 2 platines articulées (art. 300S)
n. 2 fermes d'arret (art. 430)
n. 1 platine fixe (art. 309/25)

Set en caja de carton para monorriel MS200/NA - MS200 compuesto por:
n. 2 carriles completos
n. 2 bloques de detencion
n. 1 guia inferior (art. 310)
tornillo para fijar

4S200/INOX: staffa e viti in acciaio inox. Consigliato per applicazioni esterne.
4S200/INOX: bracket and screws en inox. Recommended for outside use.
4S200/INOX: platine et vis en inox. Recommandé pour applications a l'extérieures.

INOX - STAINLESS

ART.	Confez. Box	Peso Kg Weight
S 200	6	0,775
INOX - STAINLESS S 200/INOX	6	0,775

Esempio di applicazione dello stop con ritenuta 420R - 420R/INOX

Application example of stop with restraint 420R - 420R/INOX

Ejemplo de aplicacion de tope de detencion con retencion 420R - 420R/INOX

Exemple d'application des ferme avec retenue 420R - 420R/INOX

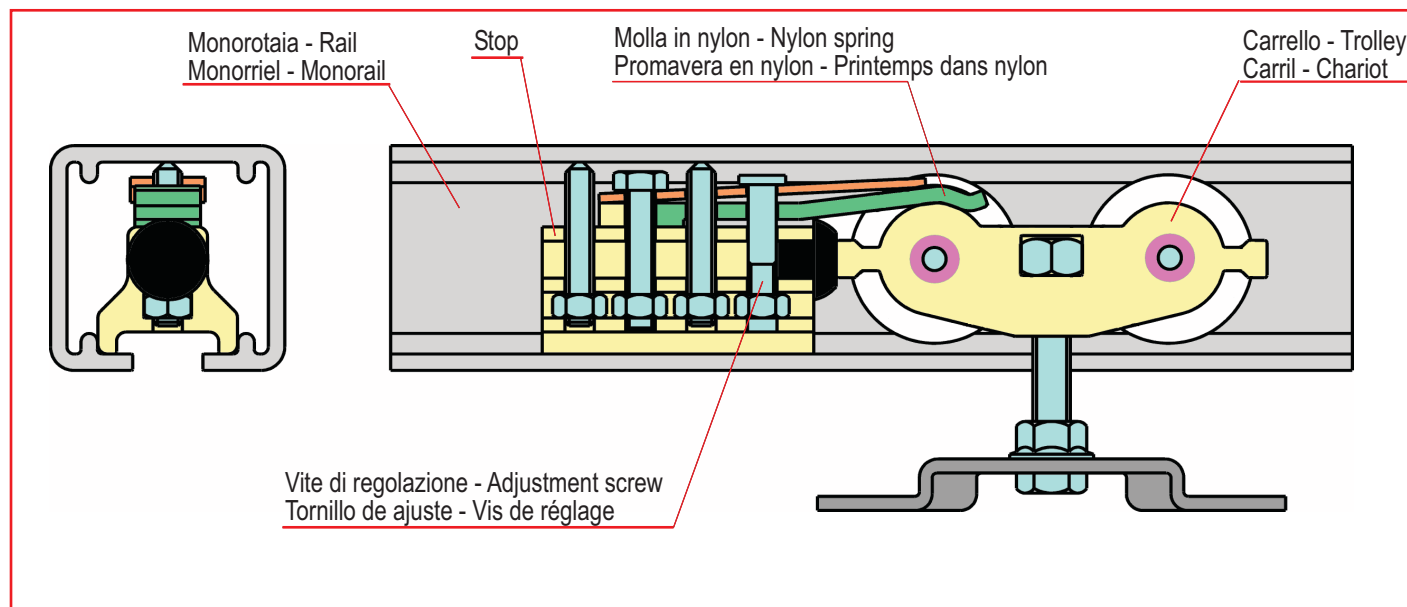

L'applicazione è valida per le serie da 200, 300 e 600 Kg.

The application is valid for 200, 300 and 600 Kg. series.

La aplicación es válida para las series de 200, 300 y 600 Kg.

L'application est valide pour les séries de 200, 300 et 600 Kg.

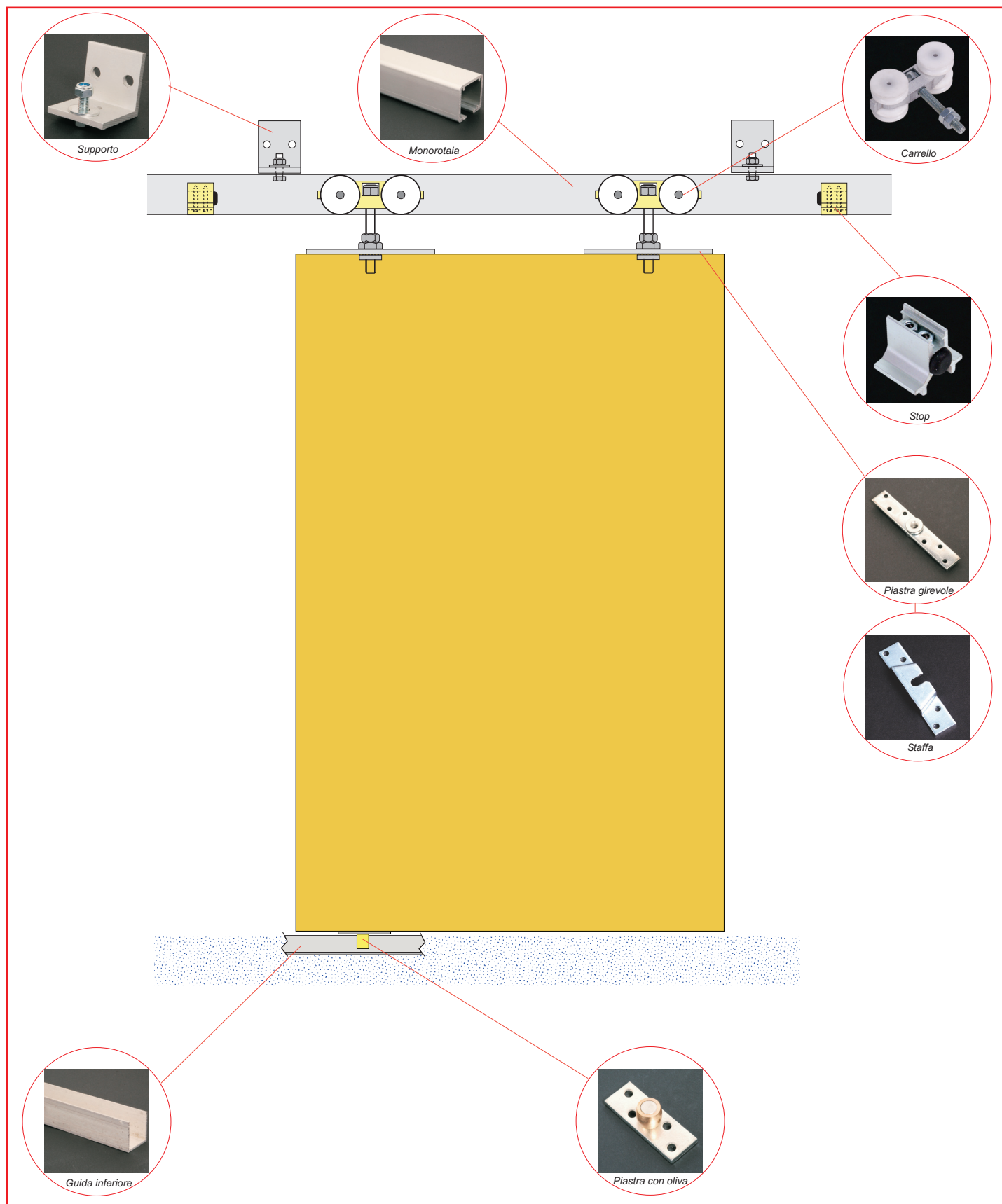



PETTITI GIUSEPPE s.p.a.

SERIE MONOSILENT

PORTATA	Per coppia di carrelli
CAPACITY	For each pair of trolleys
CAPACIDAD	Por par de carriles
PORTEE	Pour couple de chariots

SCORREVOLI PER ARREDAMENTO

SLIDINGS FOR FURNITURE

CORREDERAS PARA DECORAR

COULISSANTS POUR AMEUBLEMENT

MONOROTAIA

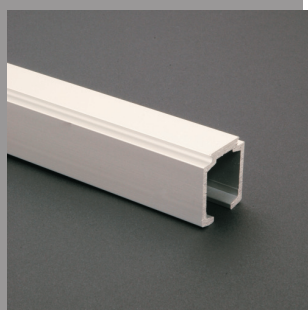

Monorotaia in alluminio anodizzato naturale
UNI-4522/66 con portata max. 20 Kg.

Rail in natural anodized aluminium
UNI-4522/66 with max. capacity 20 Kg.

Monorriel de aluminio anodizado natural
UNI-4522/66 con capacidad máxima. 20 Kg.

Monorail en aluminium anodisé naturel
UNI-4522/66 avec portée max. 20 Kg.

ART.	Confez. Box	Peso Kg Weight
MS 20	108 m n° 18x6 m	Kg/m 0,215
MS20/4	80 m n° 20x4 m	Kg/m 0,215
MS20/2	40 m n° 20x2 m	Kg/m 0,215

Monorotaia in alluminio grezzo
con portata max. 20 Kg.

Rail in rough aluminium
with max. capacity 20 Kg.

Monorriel de aluminio bruto con
capacidad 20 Kg.

Monorail en aluminium brut
avec portée max. 20 Kg.

ART.	Confez. Box	Peso Kg Weight
MS 20/NA	108 m n° 18x6 m	Kg/m 0,215
MS20/NA4	80 m n° 20x4 m	Kg/m 0,215
MS20/NA2	40 m n° 20x2 m	Kg/m 0,215

Monorotaia in alluminio anodizzato naturale
UNI-4522/66 con portata max. 40 Kg.

Rail in natural anodized aluminium
UNI-4522/66 with max. capacity 40 Kg.

Monorriel de aluminio anodizado natural
UNI-4522/66 con capacidad máxima. 40 Kg.

Monorail en aluminium anodisé naturel
UNI-4522/66 avec portée max. 40 Kg.

ART.	Confez. Box	Peso Kg Weight
MS 40	108 m n° 18x6 m	Kg/m 0,416
MS40/4	80 m n° 20x4 m	Kg/m 0,416
MS40/2	40 m n° 20x2 m	Kg/m 0,416

Monorotaia in alluminio grezzo
con portata max. 40 Kg.

Rail in rough aluminium
with max. capacity 40 Kg.

Monorriel de aluminio bruto con
capacidad max.40 Kg.

Monorail en aluminium brut
avec portée max.40 Kg.

ART.	Confez. Box	Peso Kg Weight
MS 40/NA	108 m n° 18x6 m	Kg/m 0,416
MS40/NA4	80 m n° 20x4 m	Kg/m 0,416
MS40/NA2	40 m n° 20x2 m	Kg/m 0,416

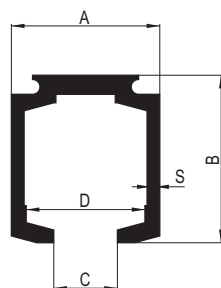

Lunghezza = 6 m - 4m - 2m
Length = 6 m - 4m - 2m
Largo = 6 m - 4m - 2m
Longueur = 6m - 4m - 2m

ART.	A	B	C	D	S
MS20	17	19	7	15	1
MS20/NA	17	19	7	15	1
MS40	26	27 ⁵	11	22	1,5
MS40/NA	26	27 ⁵	11	22	1,5
MS60	26 ²	27 ⁵	11	22	1,6
MS60/NA	26 ²	27 ⁵	11	22	1,6
MS80	30 ⁸	32	13	26	1,65
MS80/NA	30 ⁸	32	13	26	1,65
MS120	35	39 ⁵	15	28	3
MS120/NA	35	39 ⁵	15	28	3

Monorotaia in alluminio anodizzato naturale
UNI-4522/66 con portata max. 60 Kg.

Rail in natural anodized aluminium
UNI-4522/66 with max. capacity 60 Kg.

Monorriel de aluminio anodizado natural
UNI-4522/66 con capacidad máxima. 60 Kg.

Monorail en aluminium anodisé naturel
UNI-4522/66 avec portée max. 60 Kg.

ART.	Confez. Box	Peso Kg Weight
MS 60	108 m n° 18x6 m	Kg/m 0,429
MS60/4	80 m n° 20x4 m	Kg/m 0,429
MS60/2	40 m n° 20x2 m	Kg/m 0,429

Monorotaia in alluminio grezzo
con portata max. 60 Kg.

Rail in rough aluminium
with max. capacity 60 Kg.

Monorriel de aluminio bruto con
capacidad max.60 Kg.

Monorail en aluminium brut
avec portée max.60 Kg.

ART.	Confez. Box	Peso Kg Weight
MS 60/NA	108 m n° 18x6 m	Kg/m 0,429
MS60/NA4	80 m n° 20x4 m	Kg/m 0,429
MS60/NA2	40 m n° 20x2 m	Kg/m 0,429

Monorotaia in alluminio anodizzato naturale
UNI-4522/66 con portata max. 80 Kg.

Rail in natural anodized aluminium
UNI-4522/66 with max. capacity 80 Kg.

Monorriel de aluminio anodizado natural
UNI-4522/66 con capacidad maxima . 80 Kg.

Monorail en aluminium anodisé naturel
UNI-4522/66 avec portée max. 80 Kg.

ART.	Confez. Box	Peso Kg Weight
MS 80	72 m n° 12x6 m	Kg/m 0,575
MS80/4	80 m n° 20x4 m	Kg/m 0,575
MS80/2	40 m n° 20x2 m	Kg/m 0,575

Monorotaia in alluminio grezzo
con portata max. 80 Kg.

Rail in rough aluminium
with max. capacity 80 Kg.

Monorriel de aluminio bruto con
capacidad max. 80 Kg.

Monorail en aluminium brut
avec portée max. 80 Kg.

ART.	Confez. Box	Peso Kg Weight
MS 80/NA	72 m n° 12x6 m	Kg/m 0,575
MS80/NA4	80 m n° 20x4 m	Kg/m 0,575
MS80/NA2	40 m n° 20x2 m	Kg/m 0,575

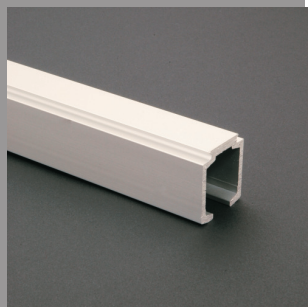

Monorotaia in alluminio anodizzato
UNI-4522/66 portata max. 120 Kg.

Rail in natural anodized aluminium
UNI-4522/66 with max. capacity 120 Kg.

Monorriel de aluminio anodizado natural
UNI-4522/66 con capacidad maxima 120 Kg.

Monorail en aluminium anodisé naturel
UNI-4522/66 avec portée max. 120 Kg.

ART.	Confez. Box	Peso Kg Weight
MS 120	72 m n° 12x6 m	Kg/m 1,120
MS120/4	40 m n° 10x4 m	Kg/m 1,120
MS120/2	40 m n° 20x2 m	Kg/m 1,120

Monorotaia in alluminio grezzo
con portata max. 120 Kg.

Rail in rough aluminium
with max. capacity 120 Kg.

Monorriel de aluminio bruto
con capacidad max. 120 Kg.

Monorail en aluminium brut
avec portée max. 120 Kg.

ART.	Confez. Box	Peso Kg Weight
MS 120/NA	72 m n° 12x6 m	Kg/m 1,120
MS120/NA4	40 m n° 10x4 m	Kg/m 1,120
MS120/NA2	40 m n° 20x2 m	Kg/m 1,120

MONOROTAIA DOPPIA IN ALLUMINIO ANODIZZATO

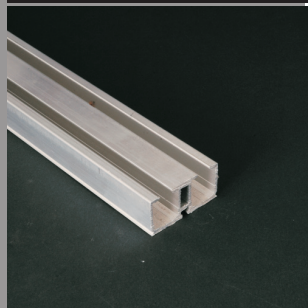

Monorotaia doppia in alluminio
anodizzato naturale UNI-4522/66
con portata max. 40 Kg. (20 Kg. x 2)

Double rail in natural anodized
aluminium UNI-4522/66 with
max. capacity 40 Kg. (20 Kg. x 2)

Monorriel doble de aluminio anodizado
natural UNI-4522/66
con capacidad maxima 40 Kg. (20 Kg. x 2)

Monorail double en aluminium
anodisé naturel UNI-4522/66
avec portée max. 40 Kg. (20 Kg. x 2)

ART.	Confez. Box	Peso Kg Weight
MS 20X2	96 m n° 16x6 m	Kg/m 0,478

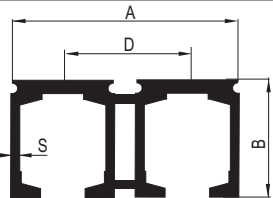

Monorotaia doppia in alluminio
anodizzato naturale UNI-4522/66
con portata max. 80 Kg. (40 Kg. x 2)

Double rail in natural anodized
aluminium UNI-4522/66 with
max. capacity 80 Kg. (40 Kg. x 2)

Monorriel doble de aluminio anodizado
natural UNI-4522/66
con capacidad maxima 80 Kg. (40 Kg. x 2)

Monorail double en aluminium
anodisé naturel UNI-4522/66
avec portée max. 80 Kg. (40 Kg. x 2)

ART.	A	B	D	S
MS 20X2	39	19	22	1
MS 40X2	56	27,5	30	1,5

ART.	Confez. Box	Peso Kg Weight
MS 40X2	96 m n° 16x6 m	Kg/m 0,930

ATTACCO SOFFITTO IN ALLUMINIO ANODIZZATO PER MS 80

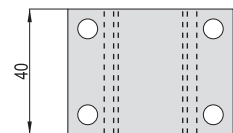
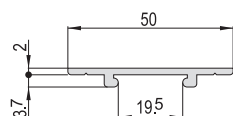
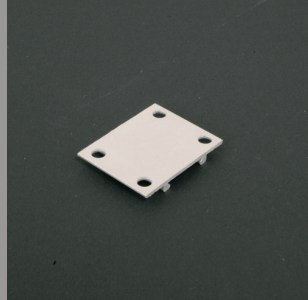

Celling attachment in anodized aluminum,
for capacity 80 Kg.

Sujetador de techo de aluminio anodizado,
con capacidad 80 Kg. .

Patte de fixation en aluminium anodisé, pour
portée 80 Kg.

completo di n.4 tasselli ad espansione.

complete of n.4 screw anchor.

completo de n.4 roscas de expansion.

comple de n.4 goujons à expansion.

ART.	Confez. Box	Peso Kg Weight
AS80	20	0,015

ATTACCO LATERALE A FASCIA IN ALLUMINIO ANODIZZATO

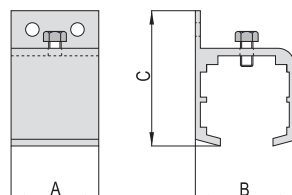
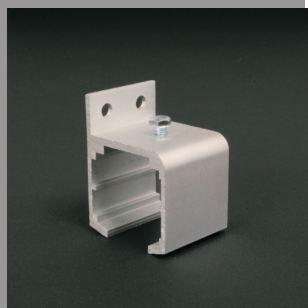

LS 20	Per mon. MS 20, MS 20/NA For rail MS 20, MS 20/NA	Larghezza max. anla: 18 mm Max. wing width: 18 mm
LS 40	Per mon. MS 40, MS 40/NA For rail MS 40, MS 40/NA	Larghezza max. anla: 29 mm Max. wing width: 29 mm
LS 60	Per mon. MS 60, MS 60/NA For rail MS 60, MS 60/NA	Larghezza max. anla: 29 mm Max. wing width: 29 mm
LS 80	Per mon. MS 80, MS 80/NA For rail MS 80, MS 80/NA	Larghezza max. anla: 35 mm Max. wing width: 35 mm
LS 120	Per mon. MS 120, MS 120/NA For rail MS 120, MS 120/NA	Larghezza max. anla: 39 mm Max. wing width: 39 mm

Lateral attachment in anodized aluminium.

Suporte lateral de aluminio anodizado.

Fixation latéral en aluminium anodisé.

ART.	A	B	C
LS 20	18	21,7	33,5
LS 40	35	33	46,5
LS 60	35	33	46,5
LS 80	35	39,5	54
LS 120	35	43	61,5

ART.	Confez. Box	Peso Kg Weight
LS 20	60	0,010
LS 40	24	0,020
LS 60	24	0,020
LS 80	16	0,040
LS 120	10	0,045

ATTACCO LATERALE IN ALLUMINIO ANODIZZATO



ART.	A	B	C
LS 40V	40	26	21
LS 60V	40	26	21
LS 80V	40	31	22
LS 120V	40	35	24

LS 40V	Per mon. MS 40, MS 40/NA For rail MS 40, MS 40/NA	Larghezza max. anta: 22 mm Max. wing width: 22 mm
LS 60V	Per mon. MS 60, MS 60/NA For rail MS 60, MS 60/NA	Larghezza max. anta: 22 mm Max. wing width: 22 mm
LS 80V	Per mon. MS 80, MS 80/NA For rail MS 80, MS 80/NA	Larghezza max. anta: 28 mm Max. wing width: 28 mm
LS 120V	Per mon. MS 120, MS 120/NA For rail MS 120, MS 120/NA	Larghezza max. anta: 30 mm Max. wing width: 30 mm

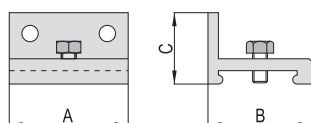

Lateral attachment in anodized aluminium.

Suporte lateral de aluminio anodizado.

Fixation latéral en aluminium 'anodise'.

ART.	Confez. Box	Peso Kg Weight
LS 40V	40	0,015
LS 60V	40	0,015
LS 80V	40	0,020
LS 120V	30	0,030

ATTACCO LATERALE REGISTRABILE PER PORTATA 40-60-80-120Kg

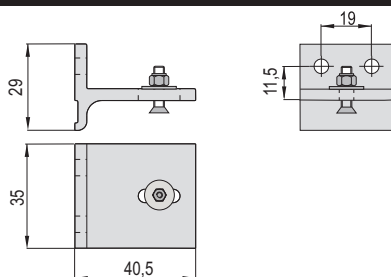
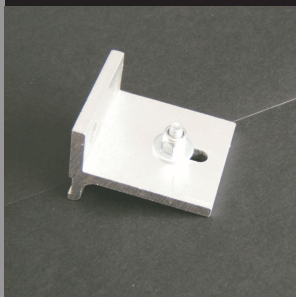

**NOVITÀ - NEW
NUEVO - NOUVEAU**

Lateral adjustable attachment, for capacity 40 - 60 - 80 - 120 Kg.

Sujetador lateral regulable, con capacidad 40 - 60 - 80 - 120 Kg.

Fixation latéral réglable, pour portée 40 - 60 - 80 - 120 Kg.

ART.	Confez. Box	Peso Kg Weight
LS 40-120	20	0,026

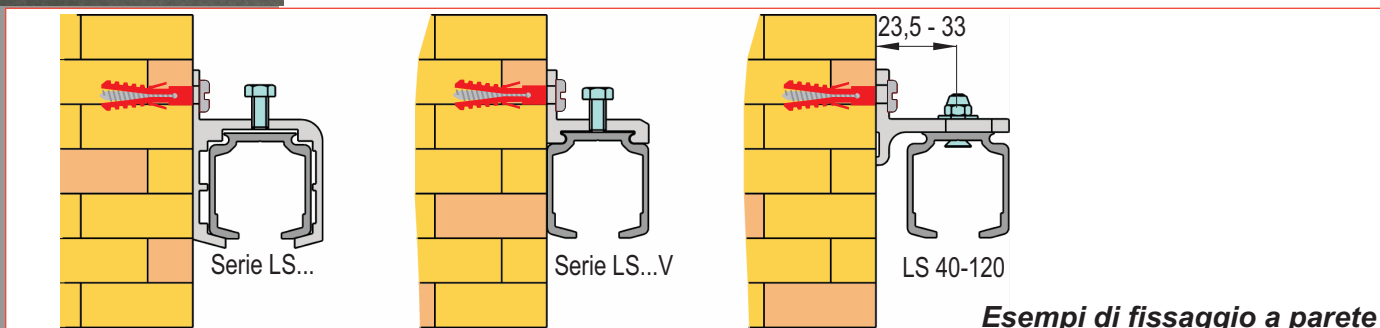

ATTACCO LATERALE DOPPIO IN ACCIAIO ZINCATO

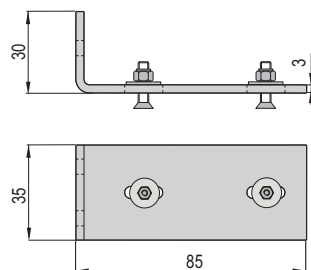

Attacco laterale registrabile per portate 40 - 60 Kg.

Lateral adjustable attachment, for capacity 40 - 60 Kg, in zinked steel.

Sujetador lateral regulable, con capacidad 40 - 60 Kg de acero galvanizado.

Fixation latéral réglable, pour portée 40 - 60 Kg. en acier zingué.

**NOVITÀ - NEW
NUEVO - NOUVEAU**

ART.	Confez. Box	Peso Kg Weight
LS 4060X2	20	0,095

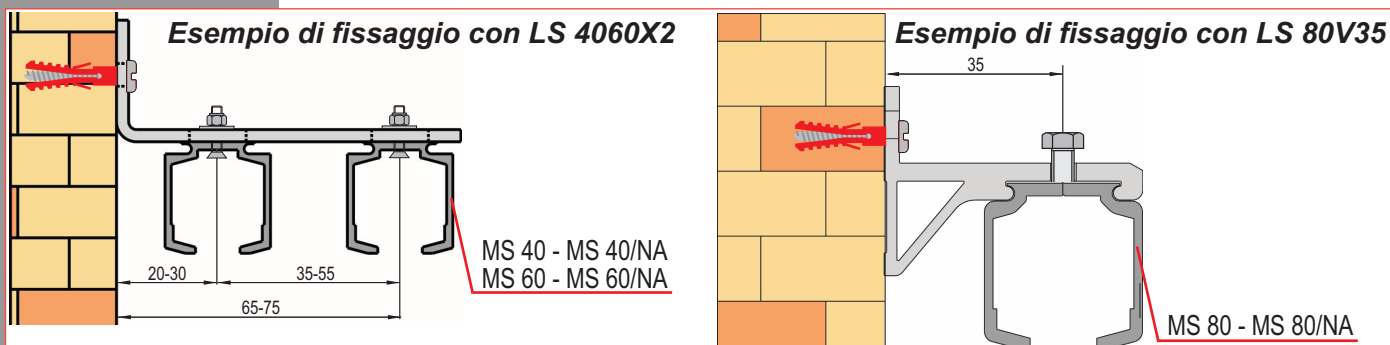

ATTACCO LATERALE LUNGO IN ALLUMINIO ANODIZZATO

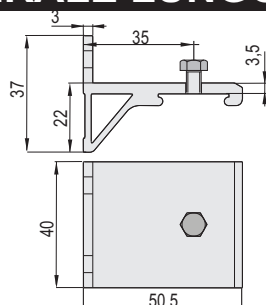

Attacco laterale in alluminio anodizzato, per portata 80 Kg.

Lateral attachment in anodized aluminium, for capacity 80 Kg.

Suporte lateral de aluminio anodizado von capacidad 80 kg.

Fixation latéral en aluminium 'anodise', pour portée 80 kg.

**NOVITÀ - NEW
NUEVO - NOUVEAU**

ART.	Confez. Box	Peso Kg Weight
LS 80V35	20	0,040

PIASTRA FISSA CON OLIVA GIREVOLE CENTRALE

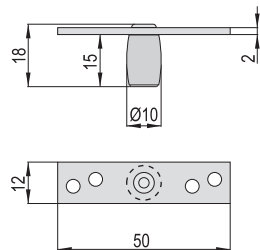
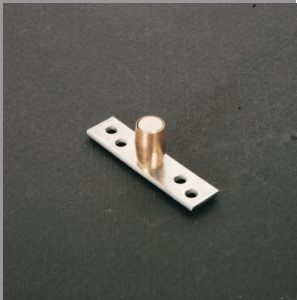

312B	Piastra in acciaio zincato, oliva in ottone. Plate in zinked steel, olive in brass. Plancha de acero galvanizado, oliva de latón. Platine en acier zingué, olive en laiton.
312BN/INOX	Piastra in acciaio inox, oliva in nylon. Plate in stainless steel, olive in nylon. Plancha de acero inox, oliva de nylon. Platine en acier inox, olive en nylon.

Fix plate with rotating olive.

Plancha fija con oliva.

Platine fixe avec olive articulée.

ART.	Confez. Box	Peso Kg Weight
312B	50	0,015
INOX - STAINLESS 312BN/INOX	50	0,015

GUIDA INFERIORE CON PERNI FISSI PER ANTE SOVRAPPOSTE

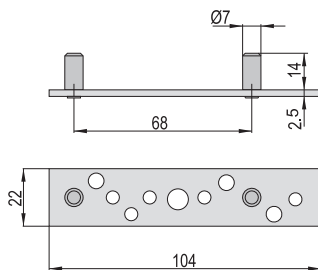
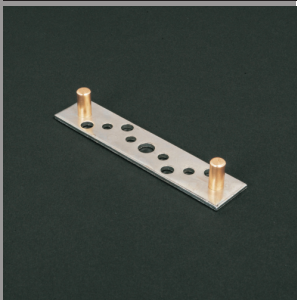

Lower guide, fix pins in brass for overlapped wings.

Guía inferior, pernios fijos de latón, para hojas sobrepuestas.

Guide inférieur, goujons fixe en laiton pour des vantaux parallèles.

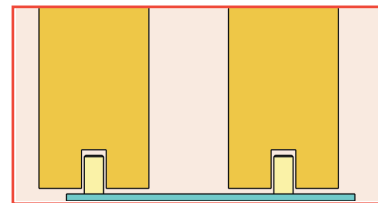

ART.	Confez. Box	Peso Kg Weight
312S	15	0,050

GUIDA INFERIORE IN NYLON

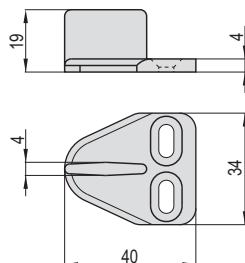

Tooth lower guide in nylon.

Guía inferior con muela de nylon.

Guide inférieure en nylon.

ART.	Confez. Box	Peso Kg Weight
312	60	0,006

GUIDA INFERIORE IN NYLON

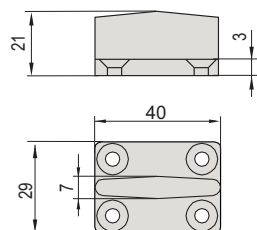

Tooth lower guide in nylon.

Guía inferior con muela de nylon.

Guide inférieure en nylon.

ART.	Confez. Box	Peso Kg Weight
312/A	60	0,006

GUIDA INFERIORE IN PLASTICA

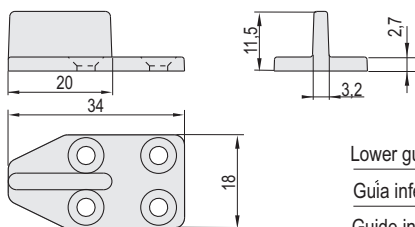
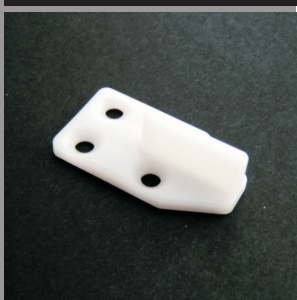

Lower guide in plastic.

Guía inferior de plástico.

Guide inférieur en plastique.

ART.	Confez. Box	Peso Kg Weight
316	50	0,002

GUIDA INFERIORE PER ANTA DOPPIA SOVRAPPOSTA, IN PLASTICA

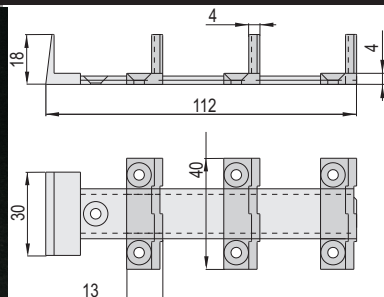

Guida inferiore per anta doppia sovrapposta, in plastica. Tagliabile a misura.

Lower guide for double over-lapped wing in plastic. To be cut on special demand.

Guía inferior para hoja doble sobrepuestas de plástico. Se puede cortar a medida.

Guide inférieur pour vantail double superpose en plastique. Coupable a mesure.

**NOVITÀ - NEW
NUEVO - NOUVEAU**

ART.	Confez. Box	Peso Kg Weight
312/4	20	0,030



Esempio di utilizzo della guida 312/4

Guida interna

Guida esterna

GUIDA INFERIORE IN NYLON

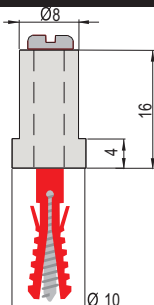
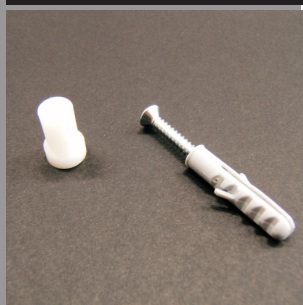

Lower guide in nylon.

Guía inferior de nylon.

Guide inférieure en nylon.

ART.	Confez. Box	Peso Kg Weight
312R	60	0,003

MANTOVANA A PARETE IN ALLUMINIO ANODIZZATO

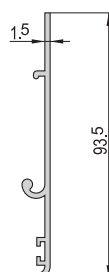

Wall gableboard in anodized aluminium, to be applied on the support (art. S M80).

Remate de pared de aluminio anodizado, para aplicar sobre el soporte (art. S M80).

Bandeau a paroi en aluminium anodisé, à appliquer sur le support (art. S M80).

ART.	Confez. Box	Peso Kg Weight
MM 80P2	32 m n° 16x2 m	Kg/m 0,470
MM 80P4	32 m n° 8x4 m	Kg/m 0,470

SUPPORTO REGOLABILE IN ALLUMINIO ANODIZZATO

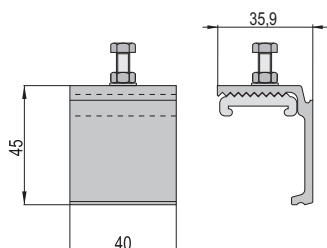

Applicabile sulle monorotaie (art. MS80 MS80/NA).

Adjustable support in anodized aluminium. Applicable on therails (art. MS80 - MS80/NA).

Supporte regulable. Aplicable sobre monorrailes (art. MS80 - MS80/NA).

Support en aluminium anodisé. Applicable aux monorails (art. MS80, MS80/NA).

Distanza tra i supporti : ~500 mm.

Distance within supports : ~500 mm.

Distancia entre los soportes : ~ 500 mm.

Distance entre les supports : 500 mm.

ART.	Confez. Box	Peso Kg Weight
S M80	24	0,045

TERMINALE REGOLABILE PER MANTOVANA A PARETE

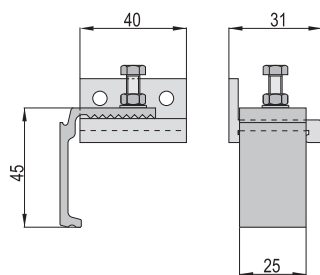
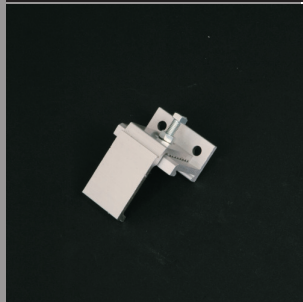

Complete adjustable, for wall gableboard.

Terminal regulable, para remate de pared.

Terminal complet, pour bandeau à paroi.

ART.	Confez. Box	Peso Kg Weight
T M80	24	0,040

MANTOVANA A SOFFITTO IN ALLUMINIO ANODIZZATO

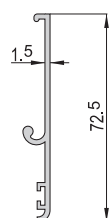
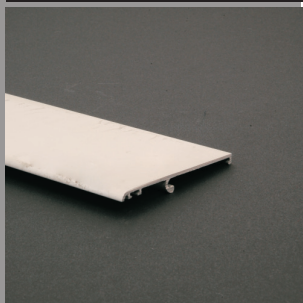

Lunghezza = 2 - 4 m

Length = 2 - 4 m

Largo = 2 - 4 m

Longueur = 2 - 4 m

Ceiling gableboard in anodized aluminium, to be applied on the support (art. S M80S).

Remate de techo de aluminio anodizado, para aplicar sobre el soporte (art. S M80S).

Bandeau au plafond en aluminium anodisé, à appliquer sur le support (art. S M80S).

ART.	Confez. Box	Peso Kg Weight
MM 80S2	32 m n° 16x2 m	Kg/m 0,390
MM 80S4	32 m n° 8x4 m	Kg/m 0,390

SUPPORTO REGOLABILE IN ALLUMINIO ANODIZZATO

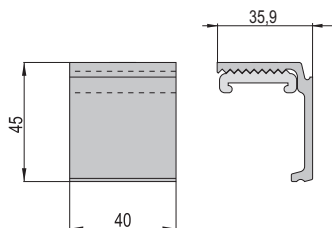

Applicabile sulle monorotaie (art. MS80 - MS80/NA).

Adjustable support in anodized aluminium.
Applicable on the rails (art. MS80 - MS80/NA).
Supporte regulable de aluminium anodizado.
Aplicable sobre monorrieles (art. MS80 - MS80/NA).

Support réglable en aluminium anodisé.
Applicable aux monorails (art. MS80, MS80/NA).

Distanza tra i supporti : ~500 mm.

Distance within supports : ~500 mm.

Distancia entre los soportes : ~ 500 mm.

Distance entre les supports : 500 mm.

ART.	Confez. Box	Peso Kg Weight
S M80S	24	0,040

SPAZZOLINO PARAPOLVERE NERO CON BASE PER INCASTRO

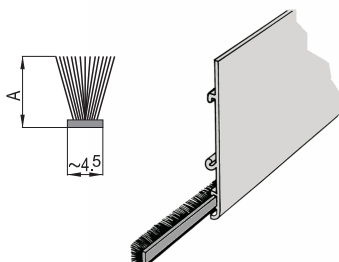

ART.	A
SMM01	8
SMM02	12
SMM03	15

Black pile weather seal for (art. MM 80P - MM 80S) with base for joint.

Cepillo antipolvo negro con base para encastrar.
Utilizable para (art. MM 80P - MM 80S).

Brosse anti poudre. Appliquer sur (art. MM 80P, MM 80S) avec base pour emboiture.

Utilizzabile per (art. MM 80P - MM 80S).

ART.	Confez. Box	Peso Kg Weight
SMM01	50 m	Kg/m 0,005
SMM02	50 m	Kg/m 0,008
SMM03	50 m	Kg/m 0,010

GUIDA INFERIORE IN ALLUMINIO GREZZO

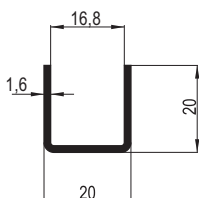
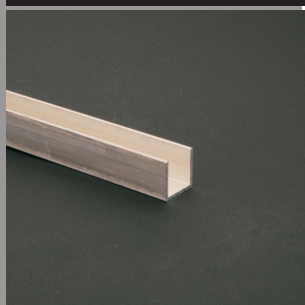

Lower guide in rough aluminium.

Guía inferior de aluminio bruto.

Guide inférieure en aluminium brut.

ART.	Confez. Box	Peso Kg Weight
GIM	72 m n° 12x6 m	Kg/m 0,235

GUIDA IN ACCIAIO OTTONATO

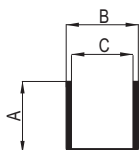
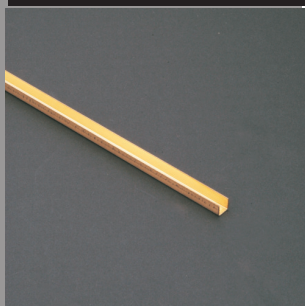

Lunghezza = 2 m
Length = 2 m
Largo = 2 m
Longueur = 2 m

Guide in brass steel

Guía de acero latonado

Guide en acier laitonné

ART.	A	B	C
AG/7	10	11,5	10,5

ART.	Confez. Box	Peso Kg Weight
AG/7	200 m n° 100x2 m	Kg/m 0,110

AGGANCO PER TRASCINAMENTO ANTE SOVRAPPOSTE

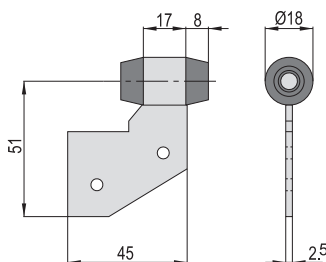

Coupler, rubber buffer, for overlapped wings.

Enganche, amortiguador de goma para hojas sobrepuestas.

Accrochage, butoir en gomme pour des vantaux parallèles.

ART.	Confez. Box	Peso Kg Weight
AF4	36	0,065

Esempio di applicazione art. AF4

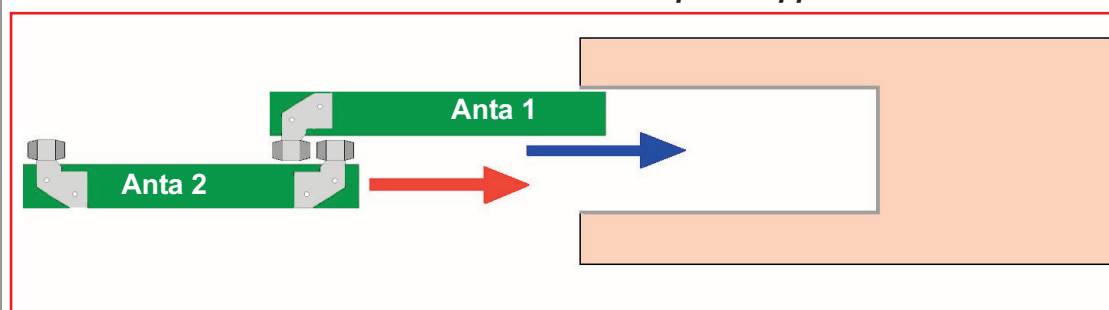

AGGANCIO PER TRASCINAMENTO ANTE SOVRAPPOSTE, IN NYLON

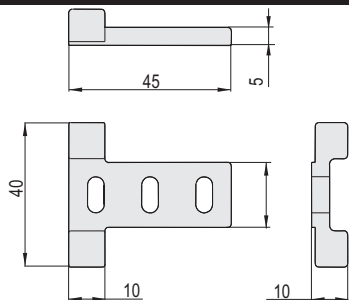
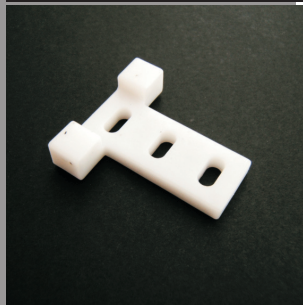

Attachement for dragging overlapped wings.
In nylon.

Enganche por arrastre de fallebas
sobrepuestas. De nylon.

Fixation pour frottement des vantaux
superposes. En nylon.

**NOVITÀ - NEW
NUEVO - NOUVEAU**

ART.	Confez. Box	Peso Kg Weight
STAFF40X45N	12	0,007

GUIDA INFERIORE PER ANTE SOVRAPPOSTE

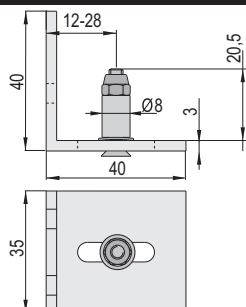
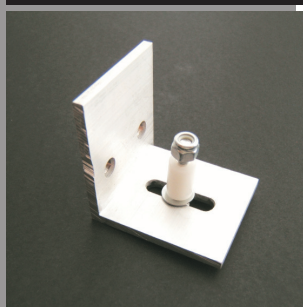

**NOVITÀ - NEW
NUEVO - NOUVEAU**

Lower guide for overlapped wings.

Guia inferior para hojas sobrepuestas.

Guide inferieure pour vantaux superposes.

ART.	Confez. Box	Peso Kg Weight
STAS/40	12	0,030

SET TRASCINAMENTO ANTE SOVRAPPOSTE

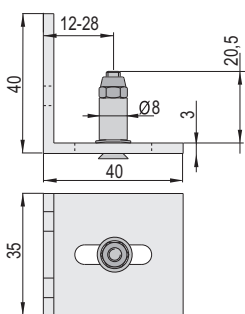

**NOVITÀ - NEW
NUEVO - NOUVEAU**

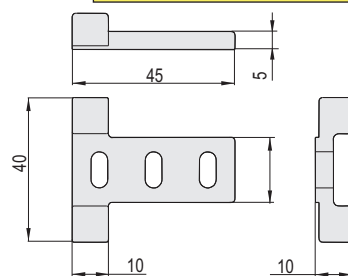

Set di trascinamento ante
sovrapposte, composto da:
1 STAS/40 staffa guida
inferiore
3 STAFF40X45N agganci
di trascinamento

Dragging set overlapped
wings including:
1 STAS/40 lower bracket
guide
3 STAFF40X45N hooks
drive

Set de arrastre fallebas
sobrepuestas compuesto
por:
1 STAS/40 estribo guia
inferior
3 STAFF40X45N ganchos
de arrastre

Set de conduite vantaux
superposes compose par:
1 STAS/40 gache guide
inferieure
3 STAFF40X45N
d'entrainement de platine

ART.	Confez. Box	Peso Kg Weight
STAS	6	0,051

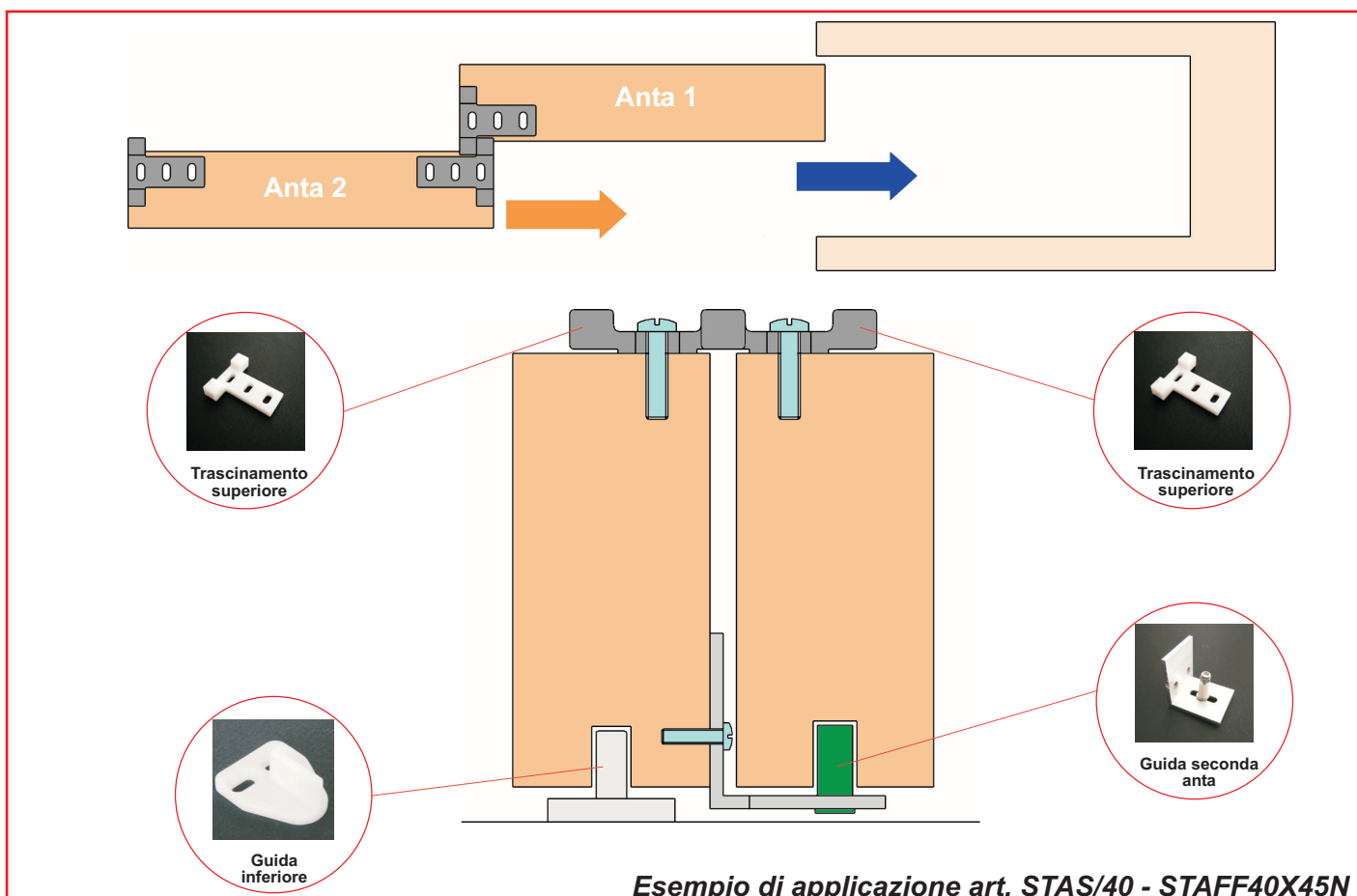

Applicazione con mantovana in alluminio.

Application with gableboard in aluminium.

Aplicación con remate de aluminio.

Application avec bandeau en aluminium.

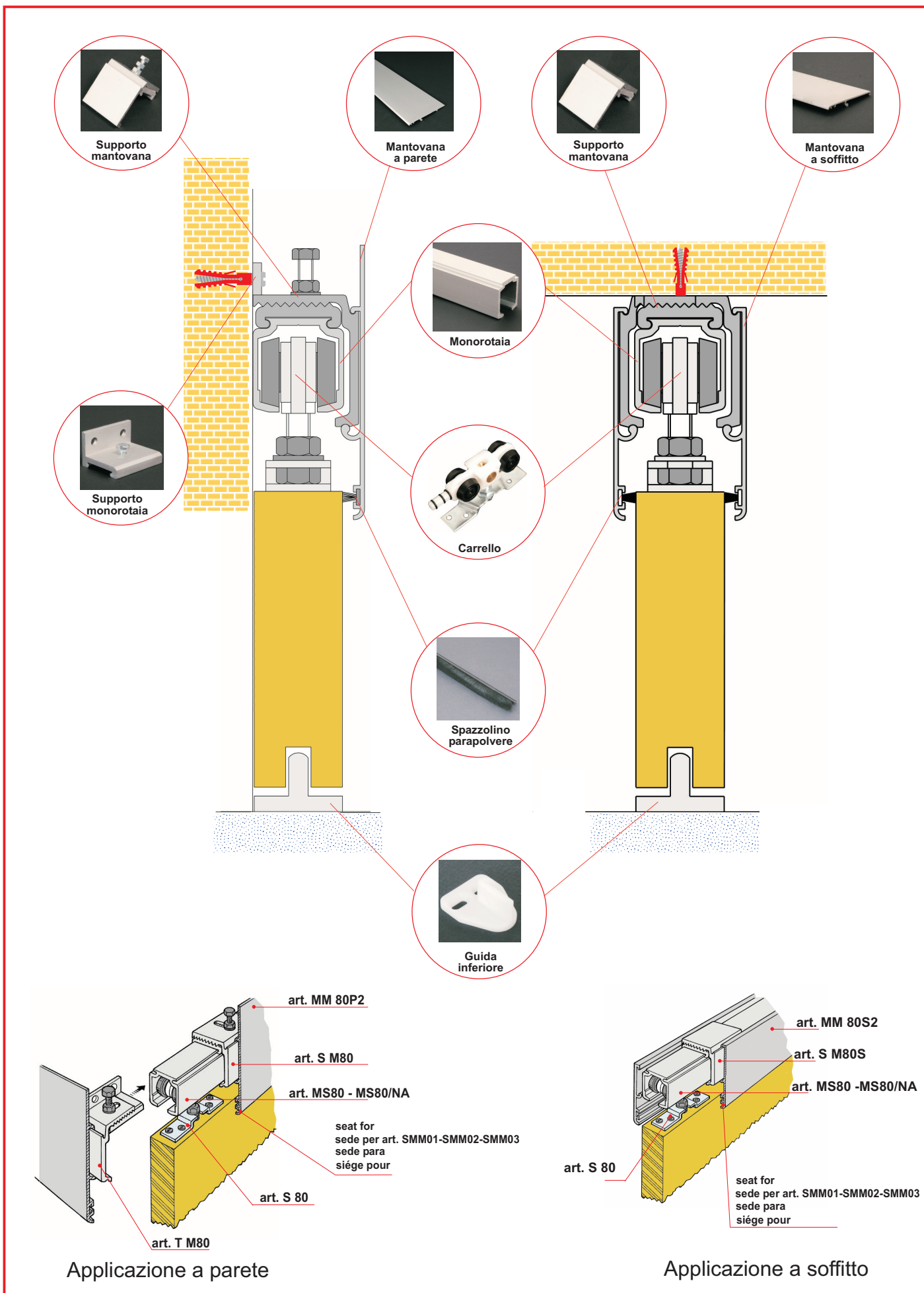

SUPPORTO REGOLABILE IN ALLUMINIO PER MANTOVANA IN LEGNO

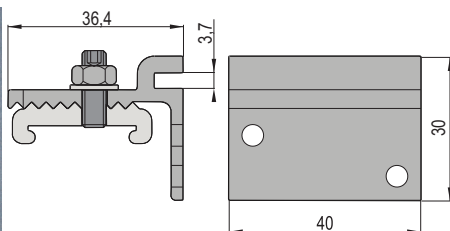
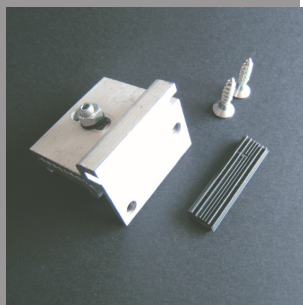

**NOVITÀ - NEW
NUEVO - NOUVEAU**

S M40L	Per mon. MS 40, MS 40/NA, MS 60, MS 60/NA For rail MS 40, MS 40/NA, MS 60, MS 60/NA
S M80L	Per mon. MS 80, MS 80/NA For rail MS 80, MS 80/NA

Fissaggio mantovana con viti o con guarnizione rigida cod.GNL
Fixing gableboard with screws or rigid gasket cod.GNL
Fixation des bandeau avec vis ou avec joint dur cod.GNL

Distanza tra i supporti : ~500 mm. Distance within supports : ~500 mm.
Distancia entre los soportes : ~500 mm. Distance entre les supports : ~500 mm.

ART.	Confez. Box	Peso Kg Weight
S M40L	5	0,039
S M80L	5	0,042

GUARNIZIONE RIGIDA PER FISSAGGIO MANTOVANA IN LEGNO

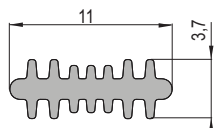
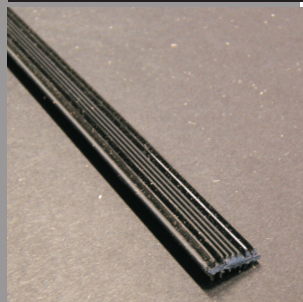

Rigid gasket for fixing gableboard in wood.
Joint dur pour fixation des bandeau en bois.

**NOVITÀ - NEW
NUEVO - NOUVEAU**

Per i supporti art. S M40L e S M80L
For supports art. S M40L and S M80L
Pour supports art. S M40L et S M80L

ART.	Confez. Box	Peso Kg Weight
GNL	10 m n°5x2 m	Kg/m 0,030

MANTOVANA IN LEGNO MDF

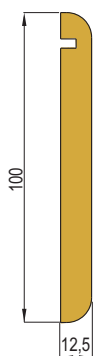

ML/G	Mantovana con rivestimento in tangerica grezzo - Gableboard with coating in tangerica Bandeau avec revêtement en tangerica
ML/B	Mantovana con rivestimento bianco rilaccabile - Gableboard with coating white painted Bandeau avec revêtement en tangerica blanc peinte
ML/A	Mantovana con rivestimento verniciato alluminio - Gableboard with coating in tangerica aluminium painted Bandeau avec revêtement en tangerica aluminium peinte

Adatta per travetto KM 80 o per le staffe SM 40L e SM 80L. Lunghezza 2.240mm
Suitable for rafter KM 80 or for the supports SM 40L and SM 80L. Length 2.240 mm
Appropriés pour soliveau KM 80 or pour supports SM 40L et SM 80L. Longueur 2.240 mm

**NOVITÀ - NEW
NUEVO - NOUVEAU**

ART.	Confez. Box	Peso Kg Weight
ML/G	1	2,100
ML/B	1	2,100
ML/A	1	2,100

ANGOLARE DI GIUNZIONE PER MANTOVANA IN LEGNO

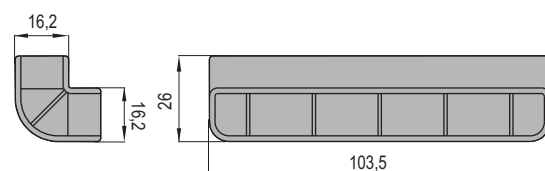
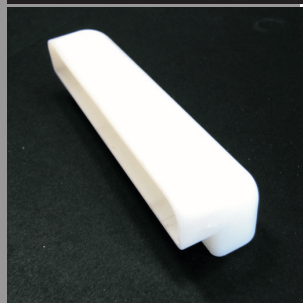

ANL/G	Angolare di giunzione a 90° in ABS grezzo - Angular of junction 90° in ABS Angulaires des jonction 90° dans ABS
ANL/B	Angolare di giunzione a 90° in ABS verniciato bianco - Angular of junction 90° in white painted ABS Angulaires des jonction 90° dans ABS blanc peinte
ANL/A	Angolare di giunzione a 90° in ABS verniciato argento - Angular of junction 90° in aluminium painted ABS Angulaires des jonction 90° dans ABS aluminium peinte

**NOVITÀ - NEW
NUEVO - NOUVEAU**

Adatta per mantovana serie ML
Suitable for gableboard ML series
Appropriés pour soliveau série ML

ART.	Confez. Box	Peso Kg Weight
ANL/G	10	0,015
ANL/B	10	0,015
ANL/A	10	0,015

KIT MONOROTAIA IN ALLUMINIO PER MANTOVANA IN LEGNO

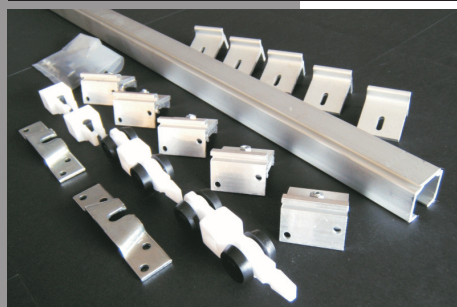

Kit formato da:
n°1 monorotaia in alluminio grezzo da 2 mt, forata
n°2 carrelli in nylon
n°2 stop pinza
n°2 staffe di fissaggio anta in acciaio zincato
n°1 guida inferiore in nylon
n°5 staffe regolabili di supporto monorotaia a parete, in alluminio (cod. LS 40-120)
n°5 staffe regolabili di supporto mantovana (cod. S M80L)

Kit including:
N°1 rail in aluminium, length 2 mt, drilled
N°2 trolleys in nylon
N°2 stop in nylon
N°2 fixing brackets in zinked steel
N°1 lower guide in nylon
N°5 support adjustable brackets for wall in aluminium (cod. LS 40-120)
N°5 support adjustable brackets for gableboard in aluminium (cod. S M80L)

Kit composé par:
N°1 rail en aluminium, longueur 2 mt, perce
N°2 chariots en nylon
N°2 fermes d'arrêt en nylon
N°2 étrier plane en acier zingue
N°1 guide inférieur en nylon
N°5 supports lateral, réglables, en aluminium (cod. LS 40-120)
N°5 supports lateral pour bandeau, réglables, en aluminium (cod. S M80L)

**NOVITÀ - NEW
NUEVO - NOUVEAU**

ART.	Portata Capacity	Confez. Box	Peso Kg Weight
KM 80	80 Kg	1	1,950

Applicazione con mantovana in legno.
Aplicación con remate de madera.

Application with gableboard in wood.
Application avec bandeau en bois.

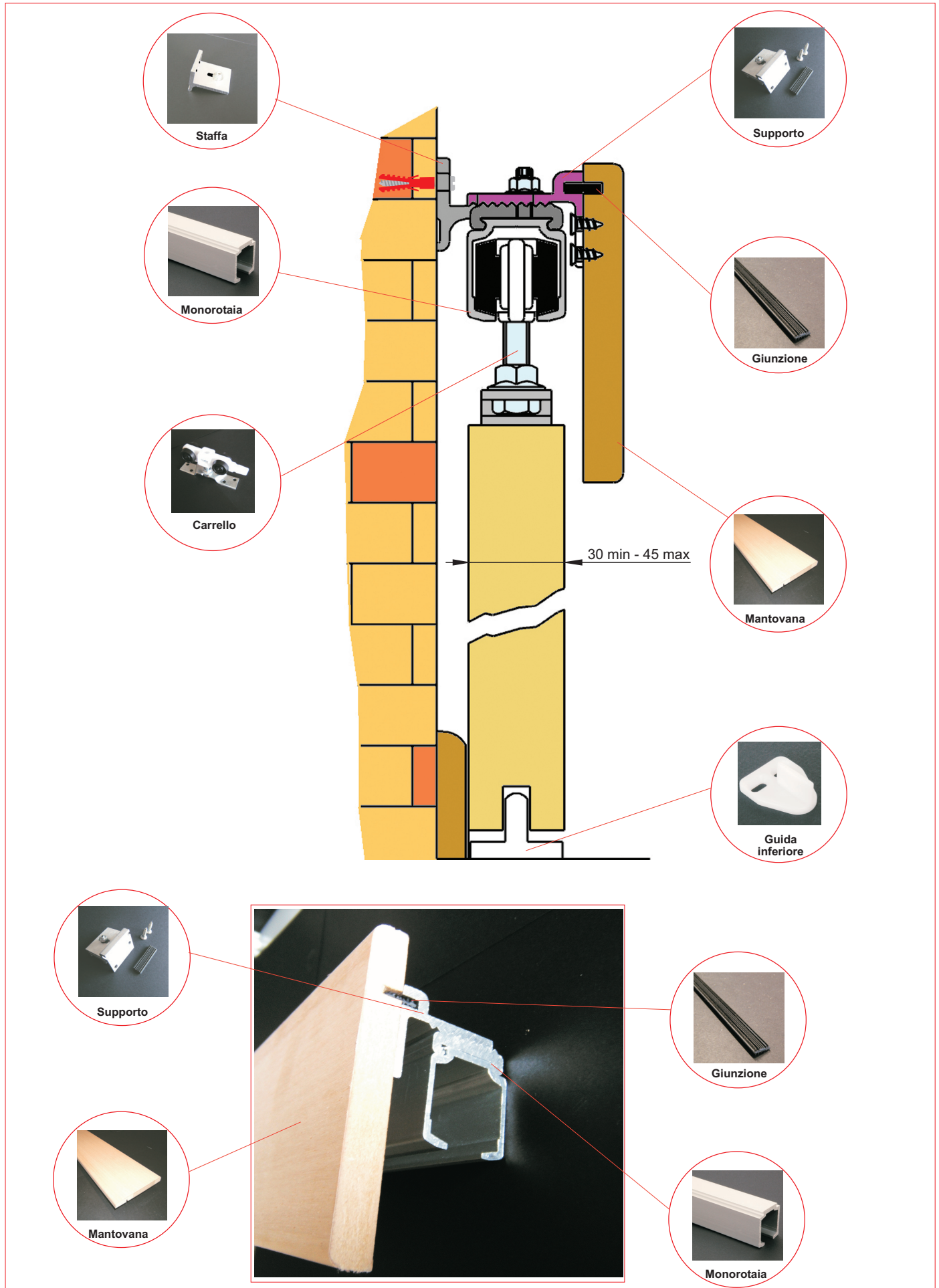

TRAVETTO IN LEGNO CON MONOROTAIA IN ALLUMINIO

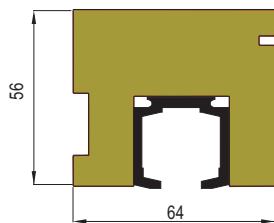
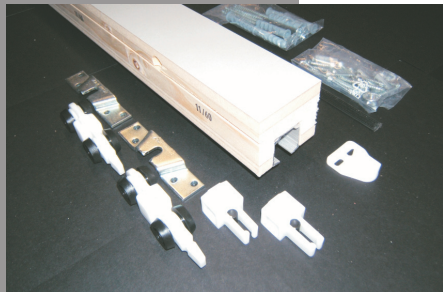

NOVITÀ - NEW
NUEVO - NOUVEAU

Kit formato da:
n°1 travetto in legno da 2 m
n°1 monorotaia in alluminio grezzo da 2 m, forata
n°2 carrelli in nylon
n°2 stop pinza
n°1 guida inferiore in nylon
n°1 sacchetto con viterie e tasselli di fissaggio a parete
n°1 giunzione rigida per mantovana, da 2 m

Kit including:
N°1 wooden rafter of 2 mt.
N°1 rail in aluminium, with holes, length 2 mt
N°2 trolleys in nylon
N°2 clips stop
N°1 lower guide in nylon
N°1 bag of fixing screws
N°1 rigid gasket for gableboard, length 2 mt

Kit compose par:
N°1 soliveau en bois of 2 mts
N°1 monorail en aluminium, percé, longueur 2 mts.
N°2 chariots en nylon
N°2 stops a pince
N°1 guide inferieur en nylon
N°1 sachet avec vis de fixation
N°1 garniture rigide pour bandeau, longueur 2 mt

ART.	Portata Capacity	Confez. Box	Peso Kg Weight
KT 80	80 Kg	1	5,000

MANTOVANA IN LEGNO MDF

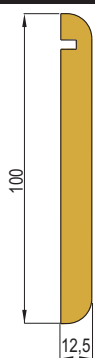

ML/G	Mantovana con rivestimento tangerica grezzo - Gableboard with tangerica cover Bandeau avec cover en tangerica brut
ML/B	Mantovana con rivestimento bianco rilaccabile - Gableboard with white cover Bandeau avec cover, blanc
ML/A	Mantovana con rivestimento verniciato alluminio - Gableboard with aluminium painted cover Bandeau avec cover aluminium peinte

Adatta per travetto KM 80 o per le staffe SM 40L e SM 80L. Lunghezza 2240mm
Applicable on rafter KM 80 or with the brackets SM 40L and SM 80L. Length 2240 mm
Applicable sur soliveau KM 80 ou avec supports SM 40L e SM 80L. Longueur 2240 mm

NOVITÀ - NEW
NUEVO - NOUVEAU

ART.	Confez. Box	Peso Kg Weight
ML/G	1	2,100
ML/B	1	2,100
ML/A	1	2,100

MONTANTE IN LEGNO CON COPRIMONTANTE

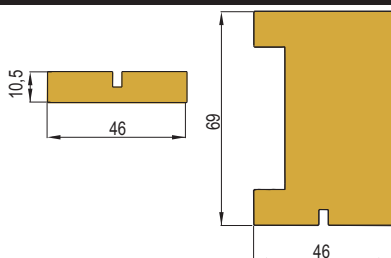
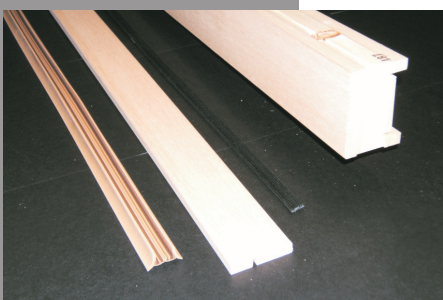

NOVITÀ - NEW
NUEVO - NOUVEAU

Kit formato da:
n°1 montante in legno da 2300 mm
n°1 coprimontante in MDF rivestito da 2300 mm
n°1 giunzione rigida per mantovana, da 2 m

Kit including:
N°1 wooden jamb, length 2.300 mm
N°1 cover jamb in mdf, length 2.300 mm
N°1 rigid gasket for gableboard, length 2 mt

Kit compose par:
N°1 montant en bois, longueur 2.300 mm
N°1 montant en mdf, longueur 2.300 mm
N°1 garniture rigide pour bandeau, longueur 2 mt

KM/G	Coprimontante con rivestimento tangerica grezzo - Cover jamb in tangerica Bandeau avec cover en tangerica brut
KM/B	Coprimontante con rivestimento bianco rilaccabile - Cover jamb white painted Bandeau avec cover blanc peinte
KM/A	Coprimontante con rivestimento verniciato alluminio - Cover jamb aluminium painted Bandeau avec cover aluminium peinte

ART.	Confez. Box	Peso Kg Weight
KM/G	1	4,900
KM/B	1	4,900
KM/A	1	4,900

ANGOLARE DI GIUNZIONE PER MANTOVANA IN LEGNO

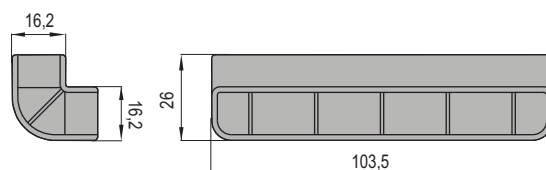
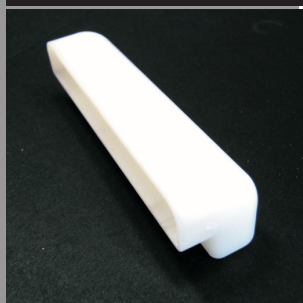

NOVITÀ - NEW
NUEVO - NOUVEAU

Adatta per mantovana serie ML
Suitable for gableboard ML series
Appropriés pour soliveau série ML

ANL/G	Angolare di giunzione a 90° in ABS grezzo - Angular of junction 90° in ABS Angulaires des jonction 90° dans ABS
ANL/B	Angolare di giunzione a 90° in ABS verniciato bianco - Angular of junction 90° in white painted ABS Angulaires des jonction 90° dans ABS blanc peinte
ANL/A	Angolare di giunzione a 90° in ABS verniciato argento - Angular of junction 90° in aluminium painted ABS Angulaires des jonction 90° dans ABS aluminium peinte

ART.	Confez. Box	Peso Kg Weight
ANL/G	10	0,015
ANL/B	10	0,015
ANL/A	10	0,015





PETTITI GIUSEPPE s.p.a.

ACCESSORI PER PORTE SCORREVOLI

MANIGLIE E SERRATURE PER PORTE IN LEGNO

HANDLES AND LOCKS FOR WOODEN DOORS

KIT MANIJAS Y CERRADURAS PARA PUERTAS DE MADERA

POIGNEES ET SERRURES POUR PORTES EN BOIS

KIT MANIGLIE E SERRATURA PER PORTE IN LEGNO

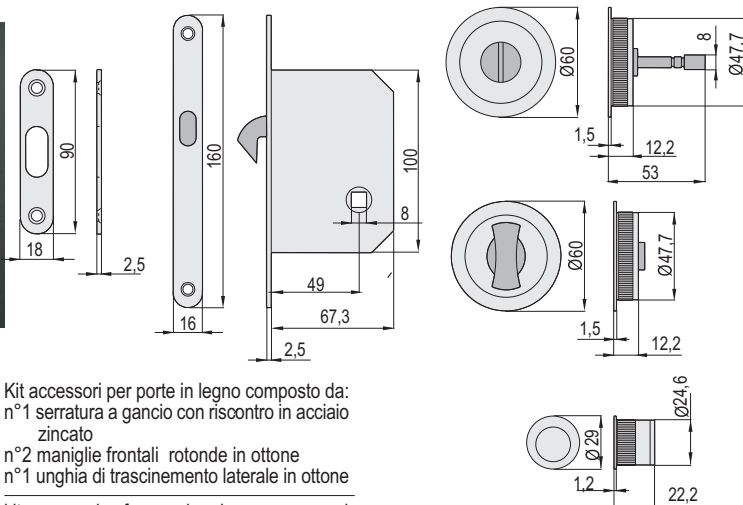

Kit accessori per porte in legno composto da:
n°1 serratura a gancio con riscontro in acciaio zincato
n°2 maniglie frontali rotonde in ottone
n°1 unghia di trascimento laterale in ottone

kit accessories for wooden doors composed from:
no. 1 lock hook with comparison in zinked steel
no. 2 front handles round brass
no. 1 nail drive side in brass

kit accesorios por puertas de madera que incluye:
nr. 1 cierre de gancho con percutor de acero galvanizado
nr. 2 manetas frontales redondas de laton
nr. 1 garra con conduccion a lado de laton

kit accessoires pour portes en bois qui comprend:
nr. 1 crochet de verrouillage avec percuteur en acier galvanise
nr. 2 poignees frontales rondes en laiton
nr. 1 taillant de conduite cote en laiton

K202/OL	Ottone lucido Polished brass Laton limpiado Laiton poli
K202/CL	Cromo lucido Polished chrome Cromo pulido Chrome poli
K202/CS	Cromo satinato Satin chrome Cromo satinado Satin chrome
K202/NS	Nickel satinato Satin nickel Nickel satinado Satin nickel
K202/BR	Bronzo anticato Bronzed Bronceado Bronzé

ART.	Confez. Box	Peso Kg Weight
K202/OL	1	0,540
K202/CL	1	0,540
K202/CS	1	0,540
K202/NS	1	0,540
K202/BR	1	0,540

COPPIA DI MANIGLIE ROTONDE IN OTTONE

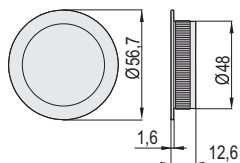
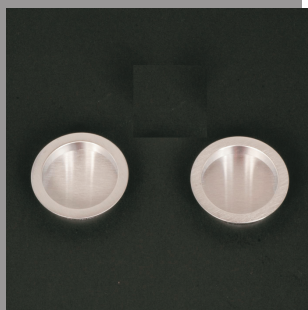

Pair of handles round in brass.

Par de manijas redondas de laton.

Paire de poignees rondes en laiton.

203/OL	Ottone lucido Polished brass Laton limpiado Laiton poli
203/CL	Cromo lucido Polished chrome Cromo pulido Chrome poli
203/CS	Cromo satinato Satin chrome Cromo satinado Satin chrome
203/NS	Nickel satinato Satin nickel Nickel satinado Satin nickel
203/BR	Bronzo anticato Bronzed Bronceado Bronzé

ART.	Confez. Box	Peso Kg Weight
203/OL	1	0,080
203/CL	1	0,080
203/CS	1	0,080
203/NS	1	0,080
203/BR	1	0,080

UNGHIA DI TRASCINAMENTO LATERALE IN OTTONE

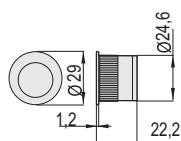

Nail drive side in brass.

Garra con conduccion a lado de laton.

Taillant de conduite cote en laiton.

204/OL	Ottone lucido Polished brass Laton limpiado Laiton poli
204/CL	Cromo lucido Polished chrome Cromo pulido Chrome poli
204/CS	Cromo satinato Satin chrome Cromo satinado Satin chrome
204/NS	Nickel satinato Satin nickel Nickel satinado Satin nickel
204/BR	Bronzo anticato Bronzed Bronceado Bronzé

ART.	Confez. Box	Peso Kg Weight
204/OL	4	0,019
204/CL	4	0,019
204/CS	4	0,019
204/NS	4	0,019
204/BR	4	0,019

MANTOVANA GREZZA PER PERSIANA SCORREVOLE

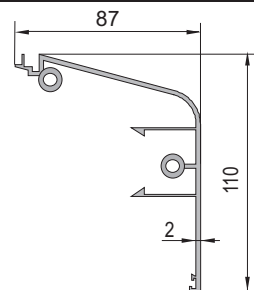
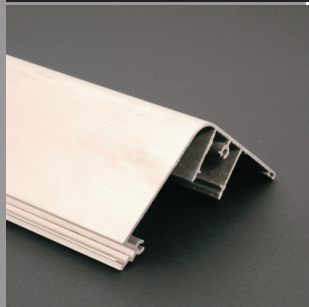

Lunghezza = 6,5 m
Length = 6,5 m
Largo = 6,5 m
Longueur = 6,5 m

Verniciatura/ossidazione a richiesta.
Painting/anodizing to be requested.
Barnizadura/oxidación a petición.
Peinture/oxydation sur demande.

Raw gableboard for sliding blind.

Remate bruto para persiana corredera.

Bandeau brut pour persienne coulissante.

ART.	Confez. Box	Peso Kg Weight
MM80E	39 m n° 6x6,5 m	Kg/m 1,286

SUPPORTO CON MONOROTAIA IN ALLUMINIO GREZZO

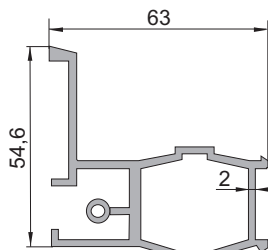

Lunghezza = 6,5 m
Length = 6,5 m
Largo = 6,5 m
Longueur = 6,5 m

Verniciatura/ossidazione a richiesta.
Painting/anodizing to be requested.
Barnizadura/oxidación a petición.
Peinture/oxydation sur demande.

Supporto con monorotaia in alluminio grezzo, per art. S 80.

Support with rail, in rough aluminium for art.S 80.

Supporte con monoriel, de aluminium brut, para art.S 80.

Support avec monorail en aluminium brut pour art.S 80.

ART.	Confez. Box	Peso Kg Weight
MS80/E	39 m n° 6x6,5 m	Kg/m 1,282

SUPPORTO CON MONOROTAIA IN ALLUMINIO GREZZO

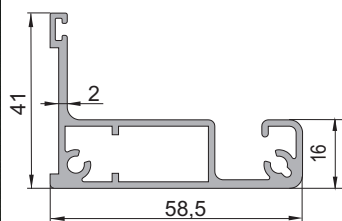

Lunghezza = 6,5 m
Length = 6,5 m
Largo = 6,5 m
Longueur = 6,5 m

Verniciatura/ossidazione a richiesta.
Painting/anodizing to be requested.
Barnizadura/oxidación a petición.
Peinture/oxydation sur demande.

Supporto con monorotaia in alluminio grezzo, per art. S 80.

Support with rail, in rough aluminium for art.S 80.

Supporte con monoriel, de aluminium brut, para art.S 80.

Support avec monorail en aluminium brut pour art.S 80.

ART.	Confez. Box	Peso Kg Weight
ML80/E	39 m n° 6x6,5 m	Kg/m 0,863

GUARNIZIONE ESTERNA NERA CON BASE PER INCASTRO

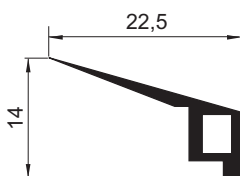
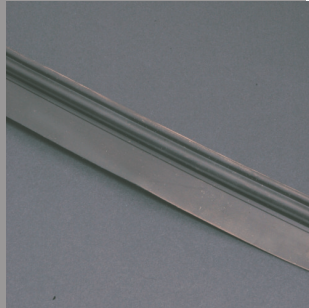

Lunghezza = 6,5 m
Length = 6,5 m
Largo = 6,5 m
Longueur = 6,5 m

Black, external, packing with fixing base.

Guarnicion exterior, negra, con base por engaste.

Garniture exterieure avec base pour emboitement.

ART.	Confez. Box	Peso Kg Weight
G/MM80E65	26 m n° 4x6,5 m	Kg/m 0,072

TAPPI DX - SX NERI PER MANTOVANA

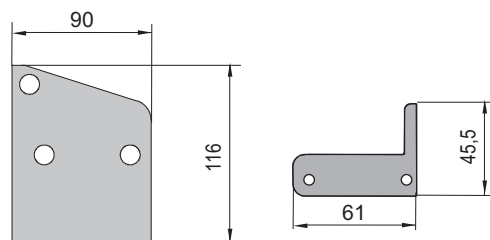
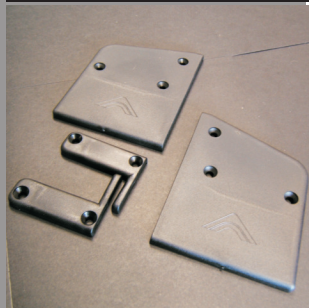

Coppia di tappi neri per art.MM 80E, 1dx, 1sx

Couple of black caps for art.MM 80E, right and left versions.

Par de tapones negros por art.MM 80E, versiones derecha e izquierda.

Couple de bouchons noirs pour art.MM 80E, version droite et gauche.

ART.	Confez. Box	Peso Kg Weight
TC/MM80E	12	0,060

PIASTRA FISSA CON OLIVA GIREVOLE

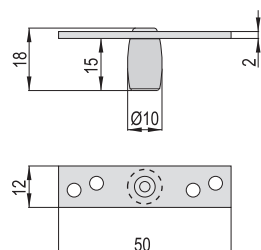
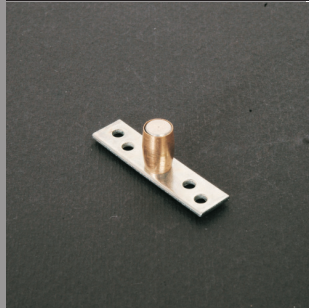

Fix plate with rotating olive.

Plancha fija con oliva.

Platine fixe avec olive articulée.

312B	Piastra in acciaio zincato, oliva in ottone. Plate in zinked steel, olive in brass. Plancha de acero galvanizado, oliva de laton. Platine en acier zingué, olive en laiton.
312BN/INOX	Piastra in acciaio inox, oliva in nylon. Plate in stainless steel, olive in nylon. Plancha de acero inox, oliva de nylon. Platine en acier inox, olive en nylon.

ART.	Confez. Box	Peso Kg Weight
312B	50	0,015
INOX - STAINLESS 312BN/INOX	50	0,015

Applicazione per persiana scorrevole
Aplicación por persiana deslizando.

Application for sliding blind.
Application pour volet coulissant.

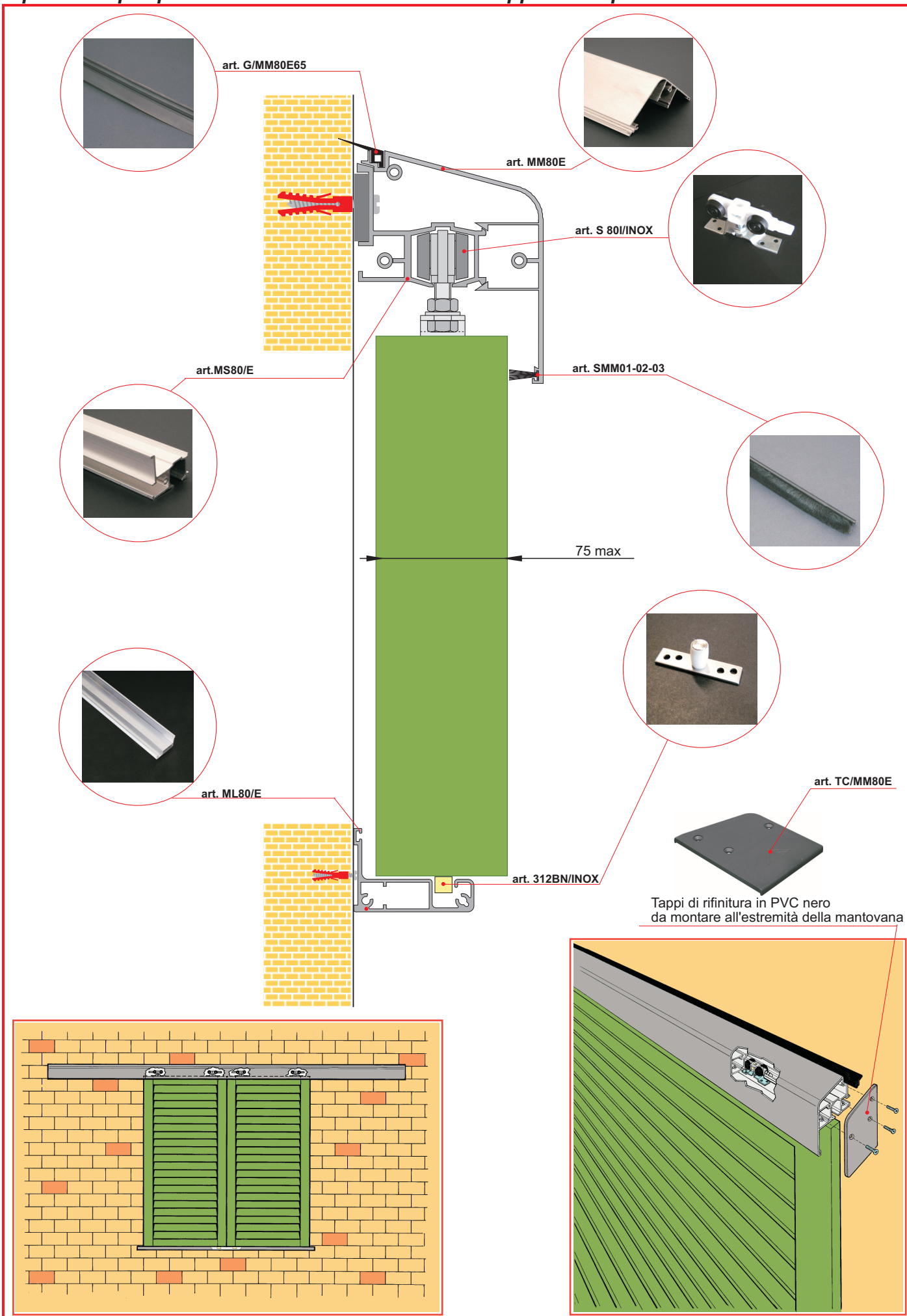

PIASTRA GUIDA INFERIORE, A PARETE, IN INOX

INOX - STAINLESS

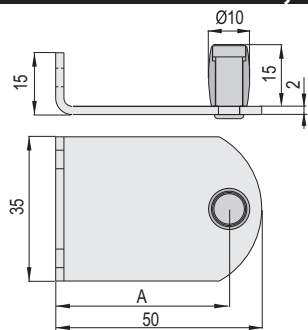

NOVITÀ - NEW
NUEVO - NOUVEAU

Wall lower guide, in stainless steel.

Guia inferior, de pared, de acero inox.

Guide inférieure, a paroi, en acier inox.

ART.	A	Confez. Box	Peso Kg Weight
312P/35/INOX	35,5	10	0,050
312P/42/INOX	42,1	10	0,050

Applicazione con 312P/42/INOX.
Aplicación con 312P/42/INOX.

Application con 312P/42/INOX.
Application avec 312P/42/INOX.

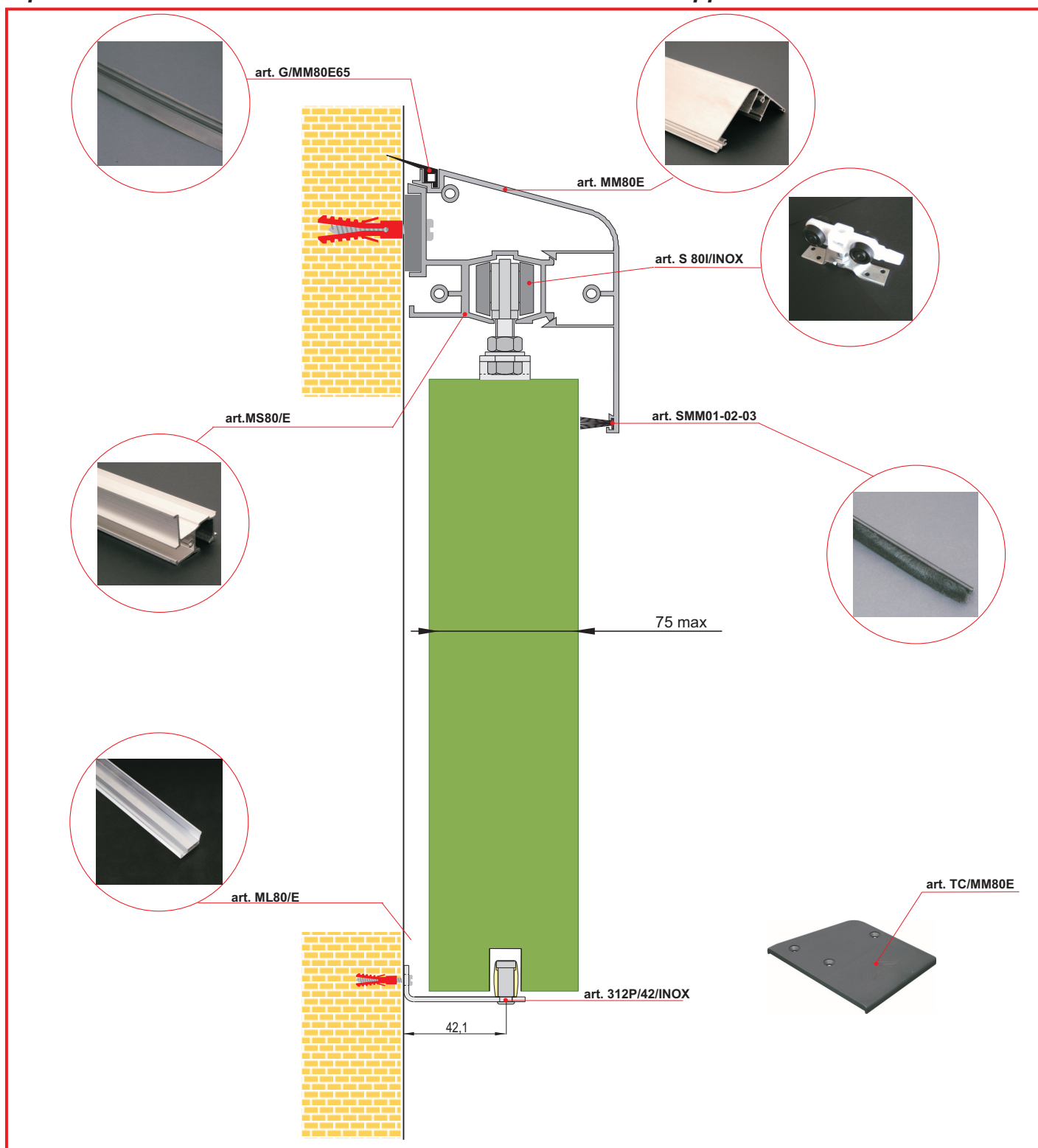

Applicazione con ante frangisole.

In collaborazione con **deceuninck**

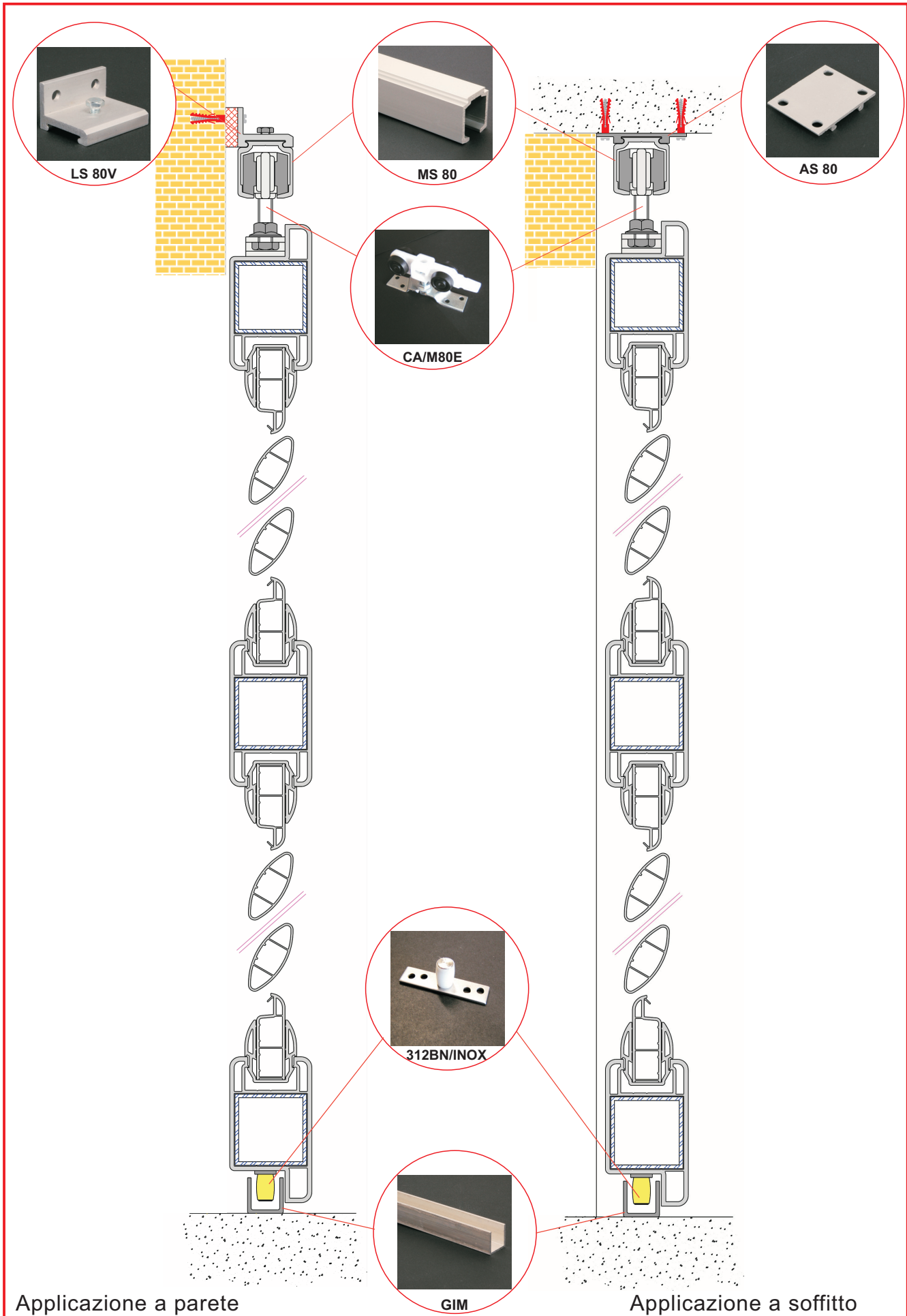

Applicazione a parete

Applicazione a soffitto

SET ACCESSORI CON AGGANCO STANDARD

ACCESSORIES WITH "STANDARD" COUPLER

ACCESORIOS CON ENGANCHE "STANDARD"

ACCESSOIRES AVEC ACCROCHAGE "STANDARD"



Set in contenitore di cartone idoneo per monorotaia MS 20, MS 20/NA, composto da:
n. 2 carrelli con perno registrabile e staffa piana sganciabile
n. 2 fermi di arresto completi
n. 1 guida inferiore + set viti di fissaggio

Set in carton box for rail MS 20, MS 20/NA including:
n. 2 trolleys with adjustable pin and detachable plane bracket
n. 2 backtop complete
n. 1 lower guide + set fixing screws

Set en caja de carton ideal para monorriel MS 20, MS 20/NA compuesto por:
n. 2 carriles con pernio regulable y abrazadera plana desenganchable
n. 2 bloques de detencion completos
n. 1 guia inferior + set de tornillos para fijar

Set en boite de carton pour monorail MS20, MS20/NA composé par:
n. 2 chariots avec pivot réglable et étrier plane détachable
n. 2 fermes d'arret complet
n. 1 guide inférieur + set vis de fixation

ART.	Confez. Box	Peso Kg Weight
S 20	24	0,125



Set in contenitore di cartone idoneo per monorotaia MS 40, MS 40/NA, composto da:
n. 2 carrelli con perno registrabile e staffa piana sganciabile
n. 2 fermi di arresto completi
n. 1 guida inferiore + set viti di fissaggio

Set in carton box for rail MS 40, MS 40/NA including:
n. 2 trolleys with adjustable pin and detachable plane bracket
n. 2 backtop complete
n. 1 lower guide + set fixing screws

Set en caja de carton ideal para monorriel MS 40, MS 40/NA compuesto por:
n. 2 carriles con pernio regulable y abrazadera plana desenganchable
n. 2 bloques de detencion completos
n. 1 guia inferior + set de tornillos para fijar

Set en boite de carton pour monorail MS40, MS 40/NA, composé par:
n. 2 chariots avec pivot réglable et étrier plane détachable
n. 2 fermes d'arret complet
n. 1 guide inférieur + set vis de fixation

ART.	Confez. Box	Peso Kg Weight
S 40	24	0,375



Set in contenitore di cartone idoneo per monorotaia MS 60, MS 60/NA, composto da:
n. 2 carrelli con perno registrabile e staffa piana sganciabile
n. 2 fermi di arresto completi
n. 1 guida inferiore + set viti di fissaggio

Set in carton box for rail MS 60, MS 60/NA including:
n. 2 trolleys with adjustable pin and detachable plane bracket
n. 2 backtop complete
n. 1 lower guide + set fixing screws

Set en caja de carton ideal para monorriel MS 60, MS 60/NA compuesto por:
n. 2 carriles con pernio regulable y abrazadera plana desenganchable
n. 2 bloques de detencion completos
n. 1 guia inferior + set de tornillos para fijar

Set en boite de carton pour monorail MS60, MS 60/NA, composé par:
n. 2 chariots avec pivot réglable et étrier plane détachable
n. 2 fermes d'arret complet
n. 1 guide inférieur + set vis de fixation

ART.	Confez. Box	Peso Kg Weight
S 60	24	0,380



Set in contenitore di cartone idoneo per monorotaia MS 80, MS 80/NA, composto da:
n. 2 carrelli con perno registrabile e staffa piana sganciabile
n. 2 fermi di arresto completi
n. 1 guida inferiore + set viti di fissaggio

Set in carton box for rail MS 80, MS 80/NA including:
n. 2 trolleys with adjustable pin and detachable plane bracket
n. 2 backtop complete
n. 1 lower guide + set fixing screws

S 80I/INOX: carrello con stop a pinza, staffe e viti in acciaio inox. Consigliato per applicazioni esterne.
S 80I/INOX: trolley with clips stop, bracket and screws en inox. Recommended for outside use.
S 80I/INOX: chariot avec stop a pince, platine et vis en inox. Recommandé pour applications a l'extérieures.

Set en boite de carton pour monorail MS80, MS80/NA composé par:
n. 2 chariots avec pivot réglable et étrier plane détachable
n. 2 fermes d'arret complet
n. 1 guide inférieur + set vis de fixation

Set en caja de carton ideal para monorriel MS 80, MS 80/NA compuesto por:
n. 2 carriles con pernio regulable y abrazadera plana desenganchable
n. 2 bloques de detencion completos
n. 1 guia inferior + set de tornillos para fijar

ART.	Confez. Box	Peso Kg Weight
S 80	24	0,450
S 80I/INOX	24	0,450



Set in contenitore di cartone idoneo per monorotaia MS 120, MS 120/NA, composto da:
n. 2 carrelli con perno registrabile e staffa piana sganciabile
n. 2 fermi di arresto completi
n. 1 guida inferiore + set viti di fissaggio

Set in carton box for rail MS 120, MS 120/NA including:
n. 2 trolleys with adjustable pin and detachable plane bracket
n. 2 backtop complete
n. 1 lower guide + set fixing screws

S 120/INOX: staffe e viti in acciaio inox. Consigliato per applicazioni esterne.
S 120/INOX: bracket and screws en inox. Recommended for outside use.
S 120/INOX: platine et vis en inox. Recommandé pour applications a l'extérieures.

Set en boite de carton pour monorail MS120, MS120/NA composé par:
n. 2 chariots avec pivot réglable et étrier plane détachable
n. 2 fermes d'arret complet
n. 1 guide inférieur + set vis de fixation

Set en caja de carton ideal para monorriel MS 120, MS 120/NA compuesto por:
n. 2 carriles con pernio regulable y abrazadera plana desenganchable
n. 2 bloques de detencion completos
n. 1 guia inferior + set de tornillos para fijar

ART.	Confez. Box	Peso Kg Weight
S 120	24	0,490
S 120/INOX	24	0,490

Portata per coppia di carrelli Capacity with 2 trolleys
 Capacidad por par de carriles Portée avec 2 chariots

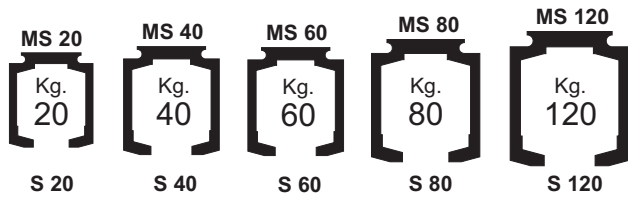

MS 20 - MS 40 - MS 60 - MS 80 - MS 120

STOP/M20 - STOP/M40
 STOP/M60 - STOP/M80
 STOP/M120

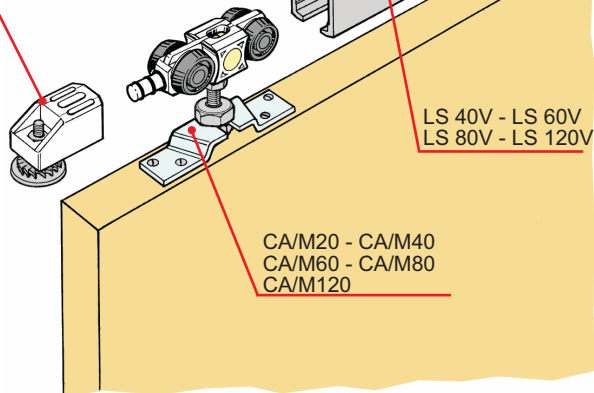

Applicazione esterno muro
 Aplicación en la pared exterior
 Application on wall
 Application sur mure

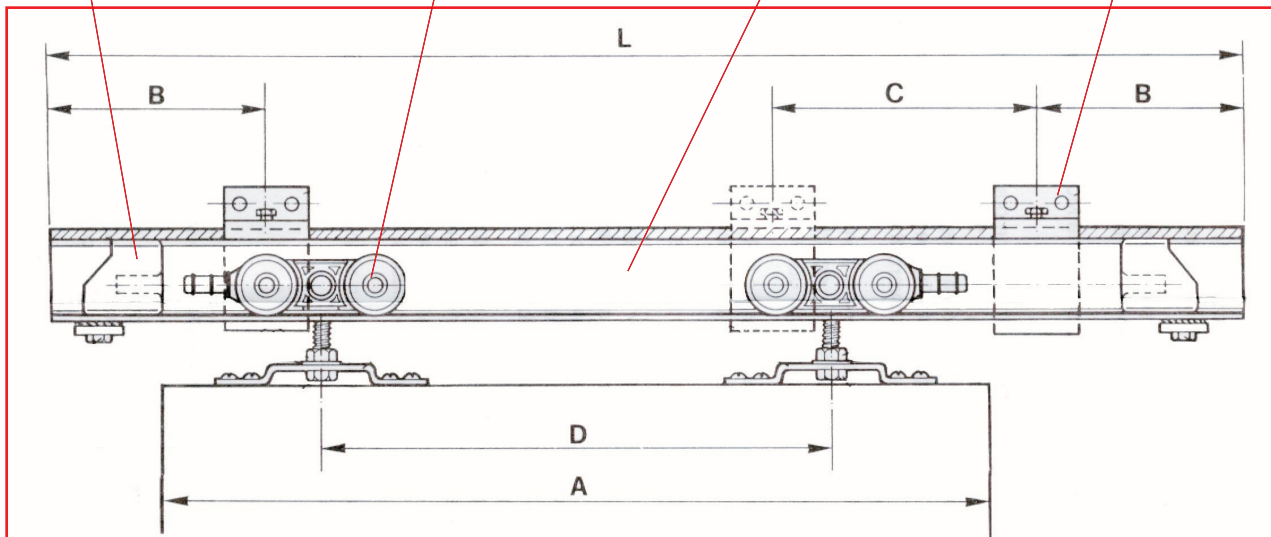
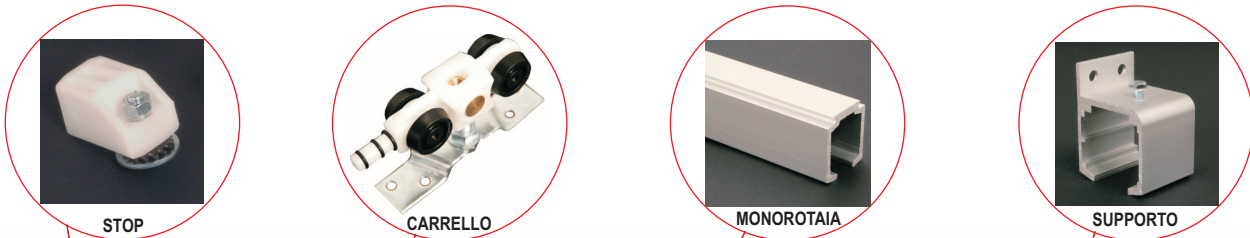
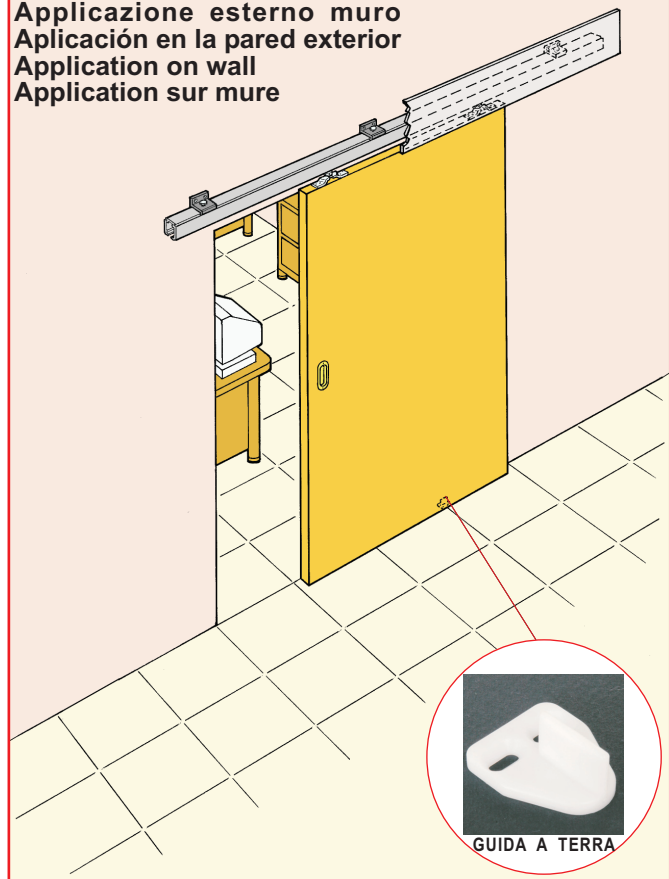

QUOTE INDICATIVE PER LA REALIZZAZIONE DEI PANNELLI
 ED UN CORRETTO POSIZIONAMENTO DEI CARRELLI E STAFFE

A	B	C	D	L	X
500 - 700	85	310	250	1.100	4
710 - 900	150	400	450	1.500	4
910 - 1200	120	415	550	1.900	5
1210 - 1500	100	420	650	2.300	6
1510 - 1800	90	470	1050	3.000	7

LEGENDA

- A= larghezza anta
- B= distanza dalle estremità delle squadrette
- C= distanza fra le squadrette intermedie
- D= interasse carrelli
- L= lunghezza totale monorotaia
- X= numero minimo squadrette